

# BevMax MEDIA

User's Guide



Tier 3

**CRANE**

3330 Dixie Narco Blvd • Williston SC 29853

[www.cranems.com](http://www.cranems.com)

English #####

# Table of Contents

<b>GENERAL INFORMATION</b> .....	3
Vender Safety Precautions.....	3
Product Identification.....	3
CE Mark & IIA Declaration.....	3
Physical Characteristics.....	3
<b>INSTALLATION &amp; SETUP</b> .....	3 - 10
Receiving Inspection.....	3
Unpacking the Vender.....	3 - 4
Electrical Requirements.....	4
Power Supply & Grounding Requirements.....	4 - 5
Installation & Setup Instructions.....	5 - 6
Placing the Vender on Location.....	6 - 7
Acceptable Ambient Operating Temperature Range.....	7
Storage Conditions.....	7
Leveling the Vender.....	7
Clearance Requirements.....	7
Installing Labels & Product ID Cards.....	7
Coin Changers and Other Accessories.....	7 - 8
Set Temperature Control.....	8
Loading the Vender.....	8
Loading the Coin Changer.....	8
Power AC Distribution Box.....	8
Vending Machine Controllers.....	8
Touch Screen Display/Keypad.....	9
Refrigeration System.....	9
Shelf Assembly.....	9
Double Gate Assembly.....	9
Slide / Pusher Assembly.....	9
Deliver (Picker) Cup Assembly.....	9
Refrigeration Deck Clamp Assembly.....	9
Belt Tensioning Adjustment Components.....	9 - 10
The Pill.....	10
Pill Lighting.....	10
<b>PROGRAMMING</b> .....	10 - 98
General.....	10
Move Thru the Menu Icons.....	10
Display of Products & Nutritional Information.....	10
Normal Operation Messages.....	11
Initial Programming.....	11
Quick Reference Menu Items.....	12 - 13
Data Recall.....	14 - 21
Diagnostics.....	21 - 32
Test.....	33 - 37
Price.....	37 - 38
Product Configuration.....	38 - 44
Special Vend Modes.....	45 - 54
Monetary.....	54 - 58
System Settings.....	59 - 70
Security Codes.....	71 - 77
Timed Events.....	77 - 84
Telemetry.....	85 - 93
Machine Configuration.....	94 - 98
<b>CONTROL BOARD</b> .....	99 - 101
LED Driver Controller Connections.....	99
I/O Controller Connections.....	100
Atlas Controller Connections.....	101

<b>TROUBLESHOOTING</b> .....	102 – 121
XY Issues.....	102 - 104
XY Not Working Flow Chart.....	105
Picker Motor Failure Flow Chart.....	106
X Motor Failure Flow Chart.....	107
Y Motor Failure Flow Chart.....	108
XY Slams to Top/Right or Left Flow Chart .....	109
Picker Cup Not Working Flow Chart.....	110
Picker Cup at Wrong Location Y Axis Flow Chart.....	111
Picker Cup at Wrong Location X Axis Flow Chart.....	112
Delivery Port Door Flow Chart.....	113
Coin Acceptance.....	114
Bill Acceptors .....	114
I/O Control Board.....	114
All Coins Rejected Flow Chart.....	115
All Bills Rejected Flow Chart .....	116
Incorrect Change Dispensed Flow Chart .....	117
Selection Will Not Vend Flow Chart.....	118
Ice / Frost on Evaporator Flow Chart.....	119
Condensate on Outside of Product Door Flow Chart.....	119
Compressor Will Not Stop Flow Chart.....	119
Compressor Will Not Start Flow Chart .....	120
Machine Not Cooling Flow Chart.....	121
<b>MAJOR COMPONENT DESCRIPTION</b> .....	122
AC Distribution Box .....	122
Service door Switches .....	122
<b>GENERAL MAINTENANCE</b> .....	122 - 124
Power.....	122
Cleaning.....	123 - 124
<b>ELECTRICAL DIAGRAMS &amp; SCHEMATICS</b> .....	125 – 128
Block Diagram Domestic .....	125
Block Diagram Export.....	126
Compressor Parts Diagram - Domestic.....	127
Compressor Parts Diagram - Export .....	128



**High Voltage Warning / Electrical Warning**  
**Danger electricity, electric shock.**



**A Generic Warning.**



**Hazard Warning: Beware of moving machinery –**  
**Entanglement hazard. Keep hands, loose clothing,**  
**and long hair away from moving parts.**



**CAUTION: This machine is designed for indoor**  
**usage only. Any other usage will void the**  
**Manufacturer’s Warranty.**



**CAUTION: The electronic system components in this**  
**machine utilize static sensitive components. Precautions**  
**for handling sensitive devices should be observed when**  
**handling these items.**

## VENDER SAFETY PRECAUTIONS

Please read this manual in its entirety. This service information is intended for use by a qualified service technician who is familiar with proper and safe procedures to be followed when repairing, replacing or adjusting any Crane Merchandising Systems vender components. All repairs should be performed by a qualified service technician who is equipped with the proper tools and replacement components, using genuine Crane Merchandising Systems factory parts. This Vender should only be used by those individuals that have a clear understanding of how to operate a vending machine in a safe manner.



*REPAIRS AND/OR SERVICING ATTEMPTED BY UNQUALIFIED PERSONS CAN RESULT IN HAZARDS DEVELOPING DUE TO IMPROPER ASSEMBLY OR ADJUSTMENTS WHILE PERFORMING SUCH REPAIRS. PERSONS NOT HAVING A PROPER BACKGROUND MAY SUBJECT THEMSELVES TO THE RISK OF INJURY OR ELECTRICAL SHOCK WHICH CAN BE SERIOUS OR EVEN FATAL.*

## PRODUCT IDENTIFICATION

First production of BevMax 6 5800-6/3800-6 Domestic and BevMax 6 5800-E6/3800-E6 Export Venders was March/April 2013. The production date of Crane Merchandising Systems products is determined by the date code incorporated in the serial number.

The vender serial number takes the form xxxx-yyyy zz. The first 4 digits (xxxx) identify the specific vender. The next 4 digits (yyyy) identify the manufacturing run that the vender was built in. The last two alpha characters (zz) identify the quarter and the year the vender was built. The first alpha character identifies the quarter as follows:

A= 1<sup>st</sup> Quarter  
 B= 2<sup>nd</sup> Quarter  
 C= 3<sup>rd</sup> Quarter  
 D= 4<sup>th</sup> Quarter

The second alpha character identifies the year:

H = 2009                      L = 2013  
 I = 2010                      M = 2014  
 J = 2011                      N = 2015  
 K = 2012                      O = 2016

The Serial Number decals are located on the top left corner of the back of the vender and on the left front edge of the product refrigerated area visible through the glass door.

## CE Mark & IIA Declaration:

An updated CE Mark or IIA Declaration document can be provided upon request: If needed please contact Technical Support Manager in Williston, SC. Phone: 1- 803-266-5001 or email [bstaub@cranems.com](mailto:bstaub@cranems.com) .

## PHYSICAL CHARACTERISTICS

	DN5800-6 DN5800-E6	DN3800-6 DN3800-E6
<b>HEIGHT</b>	73" (1854.2 mm)	73" (1854.2 mm)
<b>WIDTH</b>	47" (1193.8 mm)	40" (1016 mm)
<b>DEPTH CABINET</b>	32.05" (814.07 mm)	32.05" (814.07 mm)
<b>DEPTH WITH SERVICE DOOR</b>	33.5" (850.9 mm)	33.5" (850.9 mm)
<b>SHIPPING WEIGHT</b>	710 lbs. (322.05kg)	648 lbs. (293.93kg)
<b>Noise Level</b>	Operates at < 70db.	
Glass Door width = 37.5" (952.5 mm) 5800's. Glass Door width = 28.1" (713.74 mm) 3800's. Glass Door height = 68" (1727.2 mm) both.		

## RECEIVING INSPECTION

### DO NOT STORE THE VENDER OUTSIDE.

Upon receipt, inspect the vender for any shipping damage. Note any damage on the bill of lading and report any damage to the delivering carrier and follow their instructions. Although the terms of sale are FOB shipping point, which requires the consignee to originate shipping damage claims, Crane Merchandising Systems will gladly help if you must file a claim.

## UNPACKING THE VENDER

Remove the stretch wrap, fiberboard edge protectors and corrugated front protector from the outside of vender.



Do not store the vender with stretch wrap on. Stretch wrap could bond to the vender's surface, which could damage the finish.

Remove the shipping boards from the bottom of the vender. The shipping boards are attached by the leveling legs. To avoid unnecessary damage to the leveling legs or base, remove the shipping boards by using a 1-1/2 inch or 38mm socket type wrench to unscrew the leveling legs. Be sure to replace the legs after removing the shipping boards. Once the skid boards are removed there is 3" (76.2 mm) from base flange to the floor with the leveling legs screwed all the way in.

Once the vender is unpacked, check the "B" Tray area for any additional parts, price/product labels, service/operation manual or other information concerning factory-equipped accessories such as coin mechanism and validator.

It is recommended the vender be vend tested before shipping to the location. In programming see "Test Mode", # 9 "Test Vend" to perform test vends.



Warning

Note: Remove tape from ends of top lamp in the top lamp assembly after placing the Vender on location, but before plugging the Vender in to an AC power supply.



**WARNING: TO AVOID THE POSSIBILITY OF A FIRE HAZARD, DO NOT STORE ANYTHING OR ALLOW DEBRIS OF ANY KIND TO ACCUMULATE IN THE BOTTOM OF THE SERVICE AREA, IN AND AROUND THE REFRIGERATION COMPARTMENT OF THE CABINET, OR IN FRONT OF THE EVAPORATOR AND CONDENSER COILS.**



Warning

**WARNING: ENSURE THAT POWER IS DISCONNECTED FROM THE VENDER BEFORE INSPECTING OR REPLACING THE LAMPS, OTHER ELECTRICAL COMPONENTS, OR WORKING WITH OR ADJUSTING THE VENDING MECHANISM. FAILURE TO COMPLY WITH THESE INSTRUCTIONS MAY SUBJECT THE USER TO THE RISK OF ELECTRICAL SHOCK OR MECHANICAL INJURY, WHICH CAN BE SERIOUS OR FATAL.**



## ELECTRICAL POWER NEEDED

Refer to the cabinet serial number plate to determine the correct voltage and frequency for the machine. In the US and Canada this is 120Vac, 60Hz, 1P. In Europe, Australia, and other export countries, this is 220/230/240Vac, 50Hz, 1P depending upon your

country voltage. The serial plate also specifies the ampere rating of the machine. This machine must be plugged into a properly rated receptacle with its own circuit protection (fuse or circuit breaker).

## Equipment Nominal Power Requirements

120V / 10.2 A = \*1224W (1.224kw)

220V / 5.8 A = \*1276W (1.276kw)

240V / 5.8 A = \*1392W (1.392kw)

\*Note: Watts = V X A

## DO NOT USE AN EXTENSION CORD.

## POWER SUPPLY CORD and GROUNDING REQUIREMENTS

In accordance with the National Electrical Code and Underwriters Laboratories Inc., domestic vending machines are equipped with a three-wire power supply cord and Ground Fault Circuit Interrupter (GFCI). The GFCI device is provided as part of the power supply cord and is either incorporated directly into the plug or mounted on the cord adjacent to the plug.

### WARNING

- The **GFCI** protects against current leakage caused by ground faults. The GFCI is not designed to protect against over current or short circuits.
- **DO NOT** use the TEST and RESET buttons on the GFCI as an ON/OFF switch.
- The vending machine supply cord **MUST** be plugged directly into a properly grounded, 3 wire receptacle that is properly protected by a fuse or circuit breaker. If the receptacle will not accept the power cord plug, it must be replaced with a properly grounded, 3 wire receptacle in accordance with the National Electrical Code and Local Codes and Ordinances. The work should be done by a qualified electrician. **DO NOT USE A 3 WIRE TO 2 WIRE ADAPTOR**



Warning



Warning

**DO NOT REMOVE THE GROUND PIN ON THE PLUG OR IN ANY WAY BYPASS, MODIFY, DEFEAT, OR DESTROY THE GROUNDING SYSTEM OF THE VENDING MACHINE**

- **DO NOT USE WITH AN EXTENSION CORD.**
- **DO NOT REMOVE THE WARNING TAG ATTACHED TO THE POWER SUPPLY CORD.**
- The GFCI must be tested frequently and before each use in accordance with the instructions provided on the GFCI device. **IF THE GFCI DOES NOT PASS THE TEST, DO NOT USE THE MACHINE.** Unplug the supply cord from the receptacle and call the Crane Merchandising Systems Technical Support Group for assistance at 1-803-266-5001.

The BevMax 6 is supplied with a service cord for the country of use and is terminated in a grounding type plug. The wall receptacle for this machine must be properly polarized, grounded, and of the correct voltage. Note: Operating the machine from a source of low voltage will **VOID YOUR WARRANTY**. Each machine should have its own 15 Amp electrical circuit and that circuit should be protected with a circuit breaker or fuse conforming to local regulations.

1. **Voltage Check** – Place the leads of a voltmeter across the LINE (LIVE) and NEUTRAL terminals of the wall receptacle. The volt meter should indicate 110-130 volts ac for 120 volt, 60 Hz locations, or 220-240 volts ac for 230 volt, 50 Hz locations.
2. **Polarity Check** - Place the leads of a voltmeter across the LINE (LIVE) and GROUND terminals of the wall receptacle. The volt meter should indicate 110-130 volts ac for 120 volt, 60 Hz locations, or 220-240 volts ac for 230 volt, 50 Hz locations.
3. **Noise Potential Check** - Place the leads of a voltmeter across the NEUTRAL and GROUND terminals of the wall receptacle. The volt meter should indicate 0 volts ac. A measurement greater than 1.5-2.0 volts ac could result in problems for the machines electronic circuitry caused by electrical noise.

It is recommended that the machine be located so that the GFCI device will be accessible after the machine is installed. After installation, visually inspect the GFCI and power supply cord to be sure it is not crushed, pinched, or stretched.

Protect the power supply cord during transportation and use. Periodically inspect the power supply cord for damage. If the cord or plug is worn or damaged, it must be replaced with a power supply cord of the same type, size and specification as originally provided with the machine. **DO NOT USE THE VENDING MACHINE UNTIL THE WORN OR DAMAGED CORD IS REPLACED.**



FAILURE TO COMPLY WITH THESE INSTRUCTIONS MAY SUBJECT THE USER TO THE RISK OF INJURY OR ELECTRICAL SHOCK WHICH CAN BE SERIOUS OR FATAL. PERIODICALLY

INSPECT THE POWER SUPPLY CORD FOR DAMAGE. IF THE CORD BECOMES DAMAGED IT MUST BE REPLACED WITH THE SAME SIZE AND TYPE CORD. CONTACT CRANE MERCHANDISING SYSTEMS FOR ASSISTANCE.

## INSTALLATION AND SETUP INSTRUCTIONS

### ELECTRONIC LOCK

The electronic lock provided in the vender consists of a door mounted, motor driven 2 point latching system, cabinet mounted latch and strike system, an infrared controlled CPU, and a remote control key (FOB). The design is modular and allows for easy field service.

The electronic remote key (FOB) features a rolling code system which cannot be decoded if it is lost or stolen. After the vender has been unlocked, a new key can be programmed into it any number of times. If a key is lost or stolen, it is recommended you change the lock code in the field as soon as possible. Changing the lock code requires a new key and pressing the PROGRAM button on the lock inside the vender. The lock does not need to be changed for re-keying.

**Important:** For security reasons all Electronic Door Lock Venders are shipped less keys. Customers will need to contact the Electronic Door Lock manufacturer to order keys.

A power bypass connector, located in the product delivery port, allows auxiliary power to be applied via a battery pack to the electronic lock in the event that power is not available or there has been a failure of the internal power supply. In the event of an emergency, battery power is applied to the connector and the door can be opened and closed using the FOB.

The electronics uses an infrared transmission system, which functions similar to a television remote control. The transmission signal is line-of-sight, which requires you to aim the remote at a specific place at close range to prevent the accidental opening of several venders at the same time.

### TO OPEN THE ELECTRONIC DOOR LOCK:

1. Plug the vender into a properly powered outlet.
2. Hold the key FOB 0 to 3" (76.2 mm) in front of the Delivery Port Door and press the button on the key FOB.  
Note: The wide end of the FOB should face the door.

3. The lock will begin releasing the door. The display will indicate **OPENED**. After the motor has stopped running, you can pull the door open.

#### **TO CLOSE THE ELECTRONIC DOOR LOCK:**

##### **CAUTION: DO NOT SLAM THE DOOR CLOSED.**

Slamming the door closed can damage the electronic locking device.

1. Push the door to the cabinet until the lock motor starts. The display will indicate: **CLOSED**
2. Continue to push the door for approximately 2 to 3 seconds after the lock motor starts. The lock will pull the door closed tightly.
3. When the lock motor stops the door will be locked. Before leaving the vender, ensure that the door is locked.

The electronic door lock assembly is supplied by TriTeq Lock and Security. Crane Merchandising Systems does not carry parts for the TriTeq Electronic Door Lock. For parts and assistance, please contact:

TriTeq  
701 Gullo  
Elk Grove Village, IL 60007  
Tel: 847-640-7002  
Fax: 847-640-7008  
Email: triteqlock.com

#### **MANUAL LOCK**

Open the service door on the right side using the key provided in the coin return cup, or if shipped with a locking clip, remove the clip and install the lock. Ensure there is no power to the AC Distribution Box. On venders with a main power switch on the AC Distribution Box the switch needs to be in the OFF position. On venders with a main power quick disconnect plug on the AC Distribution Box the quick disconnect plug needs to be unplugged. Check that all connectors are firmly seated on the control board and at the various components on the service door (coin mech, keypad, etc.).

Retrieve the main power plug from the hole in the rear of the vender and plug the cord in a properly grounded 120VAC, 15 Amp receptacle (U.S. and Canada).

Open the service door and apply power to the AC distribution Box (if equipped with a bill acceptor, the acceptor should cycle twice). The display on the door will briefly show the software version in use as "Software ###.## (ie 74#. #1) followed by the default idle message "ENJOY A REFRESHING DRINK", the fluorescent lamp should be lit and the cooling unit should start. If the display shows "OUT OF SERVICE", or the cooling unit fails to start, refer to the TROUBLESHOOTING SECTION beginning on page 101.

#### **SERVICE NOTE**

##### **Battery Backup**

The battery backup is used to maintain the date and time in case of power interruptions, or any time the main power is off. When the vender is shipped, the battery is connected and memory is being maintained. If the vender is to be stored for long periods of time, disconnecting the battery is recommended. The following steps will guide you through this procedure.

- Open the service door, turn the main power switch to the off position or unplug the main power harness located on the front of the power box.
- Locate the control board mounted on the rear wall.
- Remove the battery from its holder (B1).

#### **PLACING THE VENDER ON LOCATION**

##### **!! CAUTION !!**



*DO NOT TRANSPORT THE VENDER TO OR FROM THE LOCATION LOADED WITH PRODUCT OR DAMAGE TO THE VENDER MAY RESULT.*

The vender is intended for **INDOOR USE ONLY**. **Indoor Use Only** is defined as inside a structure constructed with four walls and a roof, and sufficiently protected from ambient conditions and not subjected to the effects of weathering. The vender should be kept out of direct sunlight and away from any heat source. Do not use this vender in an environment where flammable or explosive vapors are present. This machine is not suitable for installation in an area where a water jet or hose and nozzle may be used.

The vender must be on a solid, flat and level surface. Ensure the flooring can bear the weight load of a fully loaded vender (approximately 1109 lbs. or 413kg). The vender must be positioned close enough to an electrical outlet so that an extension cord is not required. If the machine will be subject to user misuse or vandalism, it is recommended that the vender be secured to the floor or wall as described in Crane Merchandising Systems / Dixie-Narco Technical Bulletin 344. Due to the large size and weight of the Vender, never attempt to move the Vender with a Hand Truck or Stair Climber. Use a pallet jack or Vender/Cooler Dollies at all times when moving the Vender. The vender should never be slid or pushed in place. Never side load the leveling legs; doing so will cause damage to the legs. Do not transport the vender to or from customer locations loaded with product, as damage may result due to excessive weight. Be sure to test vender for proper operation before putting in to service on location. Call the Crane Merchandising Systems Technical Service

Department or your Crane Merchandising Systems Representative for assistance.

## ACCEPTABLE AMBIENT OPERATING TEMPERATURE RANGE

Generic and Pepsi BevMax 6 5800-6/3800-6 equipment manufactured by Crane Merchandising Systems is designed to work properly in a temperature range of 75°F to 90°F (23°C to 32°C) in still air 65% Relative Humidity non-condensing. Usage outside the range may cause unacceptable appearance or performance.

## STORAGE CONDITIONS

The machine is capable of being stored in a temperature range of 0°F to 155°F (-18°C to 68°C). Storage temperatures below 32°F (0°C) require the operator to take the required precautions to insure that any water is removed from the condensate system prior to storage.

## LEVEL THE VENDER

Adjust the front leveling legs, ensuring that an even gap exists between the glass door and the top security angle and receiver box, and then level the cabinet front to rear. A carpenter's level will help verify that the vender is level. Leveling legs are adjusted using a wrench or socket 1 1/2" or 38 mm in size. If the vender is to be used in a bank of equipment, check the top and sides for proper alignment. If you are unable to properly level the vender, select an alternate location. NEVER PLACE OBJECTS UNDER THE LEVELING LEGS OF THE VENDER.

### DANGER

*THE VENDER MUST BE PROPERLY LOCATED AND LEVELED. IF THE MACHINE WILL BE SUBJECT TO USER MISUSE OR VANDALISM IT IS RECOMMENDED THAT THE VENDER BE SECURED TO THE FLOOR OR WALL AS DESCRIBED IN CRANE MERCHANDISING SYSTEMS DIXIE-NARCO TECHNICAL BULLETIN 344 TO MINIMIZE THE RISK OF INJURY OR DEATH FROM TIPPING. CALL THE CRANE MERCHANDISING SYSTEMS TECHNICAL SERVICE DEPARTMENT OR YOUR CRANE MERCHANDISING SYSTEMS REPRESENTATIVE FOR ASSISTANCE.*



## CLEARANCE REQUIREMENTS

Do not block the rear of the vender. Maintain a minimum of 4 inches (10 cm) from the wall to ensure adequate airflow to the condenser and compressor. At the rear of the vender, make sure nothing obstructs the air exhaust at the bottom of the cabinet.

### WARNING

*TO AVOID THE POSSIBILITY OF A FIRE HAZARD, DO NOT STORE ANYTHING OR ALLOW DEBRIS OF ANY KIND TO ACCUMULATE IN THE BOTTOM OF THE DOOR, IN THE BOTTOM OF THE SERVICE AREA, IN AND AROUND THE REFRIGERATION COMPARTMENT OF THE CABINET, OR IN FRONT OF THE EVAPORATOR AND CONDENSER COILS.*



## INSTALLING PRICE LABELS

Pricing labels included in the literature package kit. Remove the pricing label sheets from the service manual package and gently remove the label corresponding to the vend price of each selection by tearing at the perforation. The label is installed at the top of the front knuckle. Once installed, push the label firmly against the front of the knuckle. This will insure the label is locked in place.

## INSTALLING PRODUCT ID CARDS

To assist with consistent loading, product ID cards can be installed in the product pusher to designate to the route driver which product the column is set for. To install the flavor card, simply detach it from the sheet at the perforation and slide it into the slots in the product pusher. Contact your graphics supplier to purchase as needed.

## COIN CHANGERS & OTHER ACCESSORIES

The vender is capable of accepting multiple forms of payment systems using MDB or Executive (export only) interface. If the coin changer and other MDB accessories are not factory installed, refer to the instructions received from the manufacturer of the coin changer and other accessories for proper set-up and installation.

The vender will support the following Domestic MDB coin changers:

- All available NRI MDB
- All available Currenza MDB
- All available Mars MDB
- All available Conlux MDB
- All available Coinco MDB



The vender will support the following Domestic MDB Bill validators:

- All available Cashcode MDB
- All available Currenza MDB
- All available Mars MDB
- All available Conlux MDB
- All available Coinco MDB

The vender will support Domestic MDB card readers.

## SETTING THE TEMPERATURE CONTROL

This vender is equipped with an electronic temperature sensor. Defrost is controlled both electronically based on run time of the compressor and with a manual Defrost thermostat. The temp sensor is factory pre-set to maintain a cabinet temperature of 37° Fahrenheit (2.7°C). It is also a good practice to ensure the proper operating temperature prior to installing the vender on location. To set the temperature, apply power to the vender and allow it to run for several hours with the glass door closed or until the minimum cabinet temperature is achieved. Then, using the method below, verify the temperature inside the cabinet:

With an electronic temperature sensor, use the keypad on the service door to show cabinet temperature in Fahrenheit by pressing the F key followed by the asterisk (\*) key or in Centigrade by pressing the C key followed by the asterisk key. The temperature will be shown on the digital display located on the front of the service door.

The manual Defrost thermostat is located in the bottom left of the service area. The Defrost control is preset and is not adjustable.

## LOADING THE VENDER

### CAN/BOTTLE DRINK TRAYS

The BevMax 6 5800-6/3800-6 Vender does not require spacers or shims to vend most packages. Load product in each column one package at a time insuring that the package being loaded is in front of the product pusher. Insure that the package is stable within the column (doesn't move excessively from side to side). After loading the vender, test vend each column to insure proper operation. Please contact a Service Representative or refer to the proper Technical Publication for any special settings you may need.

## LOADING CHANGE TUBES

The changer tubes can be loaded using one of the following methods:

1. Load the coin mechanism with coins to the desired level by inserting coins in the loading slots on the coin tube front.  
Minimum coin tube levels are:

- 6-8 nickels
- 7-8 dimes
- 5-6 quarters

Note: A low coin level in the coin tubes will interfere with operation of the bill validator.

2. For exact cash accountability and to insure maximum dollar bill acceptance, load the mechanism utilizing the coin insert slot on the front of the vender while in the coin TUBE FILL/DISPENSE mode in the test menu in the programming section of Technical Manual for more information.

For additional information about coin mechanism, refer to the manufacturer's instructions.

## POWER AC DISTRIBUTION BOX

The power distribution box is where the 120VAC or 220VAC input voltage is broken down to the main operating voltages of the vender (24 VAC and 12 VAC) by a transformer. Those voltages are sent to the controller via the P1 (3 pin) connector. Domestic Venders contain a 15 Amp Outlet which provides power to the Refrigeration Unit. It contains a main power switch/plug that allows power to the AC Distribution Box to distribute AC power to the lights, evaporator fan, and refrigeration system, which are always energized when the vender is powered up. It is located inside the service area, mounted to the back wall.

## VENDING MACHINE CONTROLLERS

### Atlas Control Board

The Atlas Control Board is located on the inside of the Service Door. It controls all the logic functions of the machine. It communicates with its peripherals (I/O Board, Display Board, Coin Mechanism, Bill Validator, Card Reader, Etc.) in an MDB format. It has 3 USB ports, has built in telemetry, CCM connection WLAN (Zigbee), soft boot, service button, multiple LED's for troubleshooting, interfaces with the I/O and LED boards. Note: USB3 should be used for uploading or downloading files including firmware updates.

### I/O Controller

The I/O Controller is the heart of the Glass Front Vender and is located on the rear wall inside the service area. After receiving the message from the Atlas Control Board to vend a particular selection, it determines the necessary steps to make that happen and then executes them. It then advises the Atlas Control Board of its status. It is SIM Card programmable, which controls all aspects of the vender. It also contains the power supply which regulates the voltages required to operate the motors as well as the coin mechanism, digital display, and all logic functions in the vender. The machine operating system is essentially a computer and will take a little while when you first apply power to the machine.

## **TOUCH SCREEN DISPLAY/KEYPAD**

The Touch Screen Display/Keypad is located on the front of the service door. It consists of an approximate 7.5" X 4.25" (190.5 mm X 107.95 mm) touch screen display. The touch screen display utilizes icons to move through the menu. The touch screen display is where the vender programming is accomplished and where the customers make their selections.

## **REFRIGERATION SYSTEM**

The refrigeration system is a single piece unit and is hermetically sealed. The Model BevMax 6 units consist of a 1/3 plus horsepower compressor, with a single fin and tube style condensing unit with one condenser fan, condensation overflow pan, evaporator, and evaporator fan motor. The refrigeration unit is located behind the refrigeration unit cover panels, mounted in the bottom of the cabinet. This unit is designed for easy removal and replacement from the front or rear of the vender as a complete assembly. An electronic thermostat regulates the cabinet temperature. The control of the thermostat is attached to the evaporator coils and reads the temperature of air being pulled in to the evaporator coil.

## **SHELF ASSEMBLY**

Typically, there are 5 shelf assemblies in every vender; however, this can vary depending upon the configuration specified at the time of ordering. Each can/bottle shelf consists of 9 or 7 columns. Each shelf is capable of holding a variety of packages. The shelf assembly consists of the tray, where all of the following parts are mounted: Double Gate assembly and the slide/pusher assembly. These items are discussed in detail below.

## **DOUBLE GATE ASSEMBLY (Can/Bottle Trays)**

The double gate assembly is mounted on the front portion of the tray assembly and contains the vending mechanism. Incorporated in the gate assembly are the front and rear knuckle assemblies as well as the product kicker. In standby operation, the front knuckle is in the blocking position, which holds the front displayed product in position to be vended. The rear knuckle assembly is in a flat position, which allows product to enter the gate area, and the kicker is flush to the rear knuckle assembly. A stainless steel pin is inserted through the rear most portion of the front knuckle assembly and connects to a gear box below the tray. When a selection is made, the plunger pushes the lever toward the back of the tray. At the same time the front knuckle is opened into a flat position, the rear knuckle is closed to a blocking position, holding the remaining product out of the gate area, and the kicker is extended to firmly push the

front displayed product off of the tray. The plunger is energized for approximately 1-½ seconds to allow ample time for the displayed product to be ejected from the shelf. The plunger is then released and the front knuckle returns to the blocking position, the rear knuckle and kicker return to their standby position and the next product slides into the vend display position.

## **SLIDE/PUSHER ASSEMBLY (Can/Bottle Trays)**

The slide/pusher is located on the bottom of each product column. Its purpose is to provide a slick, friction resistant surface for the product to rest on. The tall product pusher is mounted on the top of the slide and incorporates a coil spring in the body that attaches to the bottom of the slide through a slit. This spring adds needed tension to insure that all products in the column remain tight against each other and are allowed to progress into the gate area. Periodic cleaning and lubrication of the slides is recommended. **DO NOT USE SOLVENTS OR ABRASIVE MATERIALS TO CLEAN ANY PORTION OF THE TRAY.**

## **DELIVERY (PICKER) CUP ASSEMBLY**

The delivery (picker) cup assembly is located on the XY vend mechanism. Its purpose is to pick the product from the column and deliver the product to the delivery port assembly. The delivery (picker) cup assembly is mounted on the XY assembly and bolts in position.

The X axis runs left to right. The X axis assembly is cabinet mounted to prevent any cabinet torque and has one belt to synchronize the top and bottom when the X moves left or right.

The Y axis runs up and down and has the delivery (picker) cup assembly attached. A top channel is used to contain and hide the e chain and wiring.

Both X and Y motors have encoders for positioning.

## **REFRIGERATION DECK CLAMP ASSEMBLY**

The refrigeration deck clamp assembly is located on the rear left side of the cabinet base plate. Its purpose is to secure the refrigeration assembly tight against the vertical base plate for refrigerated air flow in to the cabinet. A 7/16" wrench or socket is needed to adjust the bolt.

## **BELT TENSION ADJUSTMENT COMPONENTS**

The belt tensioning adjustment components have been revised to ease adjusting belts when needed. The X Belt Idler Tensioning Assembly in the upper left hand corner of cabinet now includes a thumb screw. Adjustments should only be needed if a belt is replaced.

The Bottom X Drive Tensioner Assembly in the lower right hand corner of cabinet has a plastic spring

loaded tensioning wheel to keep the belt against the pulley when moving and does not require any adjustments.

## The Pill (Sign)

The Pill is what we refer to the polycarbonate front on the service door. The Pill covers the Surround Lighting and surrounds the Touchscreen, Integrated Payment System, and Payment Options. You must know the payment options you wish to use to have the correct Pill installed for your order. Pills may be ordered and replaced in the field as required.

## Pill Lighting

- **Surround Lighting**

The Surround Lighting can be changed in programming to Red, Blue, White, Green, Purple, Orange, or Yellow. The Surround and LED Lighting are controlled by the LED Driver Board. Surround Lighting is powered by J7 & J8 of the LED Driver Board.

- **LED Integrated Lighting**

The LED Lighting lights up the integrated coin and bill insert and card swipe openings. The Surround and LED Lighting are controlled by the LED Driver Board. LED Lighting is powered by J9, J16, & J18 of the LED Driver Board.

## PROGRAMMING

### GENERAL INFORMATION

- In order to fully utilize the many features of your vender it is important that you first understand the options available and procedures for programming the vending controller unit (control board). All programming, testing, and service functions are accomplished by using the touch screen in an easy to follow display prompted format. In stand-alone operation there are twelve programming modes for servicing, testing, and setting up your vender. The Operator programming modes are accessed by opening the service door and entering the 4 digit PIN number when prompted for it on the display. From the factory this PIN number is set to 3333. Once entered the Touch screen will show programming option icons that need to be pressed to access menu modes. There are several other programming modes that provide different menu options. They include Driver Menu, Manufacturing Menu, and Engineering Menu options. Information for these modes is covered in the Security Codes Mode programming section of this manual.

## To Move through the Menu:



goes back one step in program.



goes back to the home menu screen.



not used at this time



not used at this time

## DISPLAY of PRODUCTS and NUTRITIONAL INFORMATION

Allows the consumer to view the product, cost, and nutritional information of the selected product before making a purchase. Crane Merchandising Systems is providing the nutritional content information based on information provided by the product manufacturers, and Crane Merchandising Systems cannot accept responsibility for content created by others.

- Press the product selection number. The display will show a picture of the product and the price of the product. Sample:



- Press the icon as instructed to view the nutritional information of the product. Sample:

Nutritional Information	
Serving Size	
Calories	240
% Daily Value	
Total Fat	16g
25%	
Sodium	250mg
11%	
Total Carbohydrates	23g
8%	
Sugar	1g
Protein	3g
Not a significant source of Other nutrients	

## NORMAL OPERATION MESSAGES

At initial power-up, the program will start just like your home computer and the Touch screen will display Crane, followed by a running list of all activities being checked during power up. The lights on vender will cycle on and off, validator if installed will cycle, coin return plunger motor will cycle, and then:

- If Errors exist, an error list will be displayed that includes the time and date of the error. To exit or escape to the home screen press the back arrow icon on Touch Venders.
- If No errors exist, the home screen will appear with programming menus.

## INITIAL PROGRAMMING

### TO VIEW DATA RECALL

To view a listing of the Data recorded for non-resettable sales data, resettable sales data, events, and identification numbers enter the "DATA RECALL" mode by opening the service door, entering the PIN number, and pressing Data Recall icon on screen. Use the top arrow and bottom arrow on the right side of the screen to scroll through the multiple screens if needed. Refer to the "Data Recall" programming section for descriptions of available Data that is recorded to be displayed.

### TO VIEW ERRORS REGISTERED

To view a listing of errors along with the date and time they occurred enter the "Diagnostics" mode by opening the service door, entering the PIN number, and pressing the Diagnostics icon. Use the top arrow and bottom arrow on the right side of the screen to scroll through the multiple screens if numerous errors have been recorded. Refer to the "Diagnostics"

programming section for error descriptions, probable causes, and possible solutions for many of the errors that may display.

## TO TEST VENDER OPERATIONS

To test the different operations of the vender enter the "Test" mode by opening the service door, entering the PIN number, and pressing the Test icon. Follow the menu prompts or refer to the "Test" programming section in this manual for step by step instructions to perform tests for vending, coin return motor, surround lighting, screen, refrigeration, MagTech Head, cashless system, monetary, port & cup sensors, platform movement, and lighting.

## TO SET PRICES

To set the prices enter the "Price" mode by opening the service door, entering the PIN number, and pressing the Price icon. Follow the menu prompts or refer to the "Price" programming section in this manual for step by step instructions. This menu allows you to set regular prices for an individual item, a complete tray, or the entire machine. For other pricing options you need to refer to the following programming sections: "Special Vend Modes" or "Timed Events".

## TO SET DATE/TIME

To set the date and time enter the "System Settings" mode by opening the service door, entering the PIN number, and pressing the System Settings icon. Follow the menu prompts or refer to the "Time & Date" programming section in this manual for step by step instructions.

## TO SET NEW PIN

To set a new PIN enter the "Security Codes" mode by opening the service door, entering the PIN number, and pressing the Security Code icon. Follow the menu prompts or refer to the "Security Codes" programming section in this manual for step by step instructions.

## TO SET STS

To set Space to Sales open the service door, enter the PIN number, and press the Product Configuration icon, then press the FIFO Setup icon or refer to the FIFO Setup programming section in this manual for step by step instructions.

For all other options please refer to the programming quick reference chart on the following pages and the related programming section in this manual for step by step instructions.

**BEVMAX MEDIA – PROGRAMMING MAP  
SOFTWARE VERSION 10.7.2 KEYPAD**

<b>Data Recall</b>		<b>Pg</b>	<b>Price</b>		<b>Pg</b>	<b>Special Vend Modes</b>		<b>Pg</b>	<b>System Settings</b>		<b>Pg</b>
1	Non-Resettable Sales Data	14	1	By Tray 1	37	1	Free vend	45	1	Machine Information	59
	1. Overall Totals	14	2	By Tray 2	37	2	Winner Mode	45	2	Time & Date	60
	2. by Tray	15	3	By Tray 3	37		1. Add Group	45	3	Language	62
	3. by Product	15	4	By Tray 4	37		2. Delete Group	47	4	DTS (Data Transfer System)	63
	4. Cash	16	5	By Tray 5	37		3. Edit Group	47		1. DTS Standby mode	63
	5. Cashless	16	6	By Entire Machine	37		4. Winner Selections Mappings	48		2. DTS Audit List	63
	6. Bill Data	16	7	By Individual Selection	38	3	Combo Vends	48		3. CA304/CA308 Data Type	64
2	Resettable Sales Data	17					1. Discount Type	48		4. OnBoard Cashless Data	64
	1. Overall Totals	17	<b>Product Configuration</b>				2. Add New Combo	48		5. Data Reset on Transfer	64
	2. by Tray	17	1	Selection Configuration	39		3. Delete Promotion	50		6. Event Data Reset on Transfer	64
	3. by Product	18		1. Tray 1	39		4. Edit Promotion	51		7. Pass-Code Reset	64
	4. Cash	18		2. Tray 2	39		5. Combo Vend Selection	52		8. DTS Cache Settings	65
	5. Cashless	19		3. Tray 3	39	4	Token Enable	53	5	Software Updates	65
	6. Bill Data	19		4. Tray 4	39	5	Rapid vend	53	6	Backup/Restore	66
	7. Clear Data	19		5. Tray 5	39	6	Multivend Discount	54	7	Clone (copy) Configurations	67
3	Events	20	2	FIFO Set-Up	39	<b>Monetary</b>				1. Prepare Flash Drive	67
	1. Power Losses	20		1. Add Group Menu	39	1	Coins In/Out	55		2. Create Config Clone	67
	2. Door Events History	20		2. Delete Group	40		1. Stop Dispensing	55		3. Install Config Clone	67
4	Identification Numbers	21		3. Edit FIFO Group	41		2. 0.05	55		4. Remove Clone from Stick	67
5	Mech, Validator, Cashless	21		4. FIFO Mappings	42		3. 0.10	55	8	Clone (copy) Board	68
<b>Diagnostics</b>			3	UPC/EAN Codes	42		4. 0.25	55	9	Screen Brightness	68
1	Screen Data	21	4	Shopping Cart Set-Up	43		5. Set Up Channels	55	10	LED Color	68
2	Diagnostics Errors	22		1. Shopping Cart Size	43	2	Bill Validator	56	11	Idle Time Out	69
				2. Max. Fund Amount	44	3	Coin Mechanism	56	12	Advertisements	69
<b>Test</b>			5	View Plan-O-Gram	44	4	Card Reader A	56	13	Custom Messages	70
1	Test Vend	33		1. Tray 1	44	5	Card Reader B	56	14	Automatic Reboot Settings	70
2	Coin Return Motor	33		2. Tray 2	44	6	On Board Cashless Enable	57	15	Ship Main Menu	70
3	Surround Lighting Test	34		3. Tray 3	44	7	Correct Change Parm	57			
4	Screen Test	34		4. Tray 4	44		1. Declining Balance	57			
5	Refrigeration System	34		5. Tray 5	44		2. Force Vend	57	<b>Security Codes</b>		
6	MagTeck Head Test	35					3. Accept on low change	57	1	Enter PIN	71
7	Cashless system test	35					4. Low change message	58		1. Details for Driver PIN	71
8	Monetary	35					5. Credit for failed vend	58		2. Details for Operator PIN	71
9	Port & Cup Sensors	36					6. Allow consumer over pay	58		3. Details for Engineers PIN	73
10	Platform Movement	36				8	Stack Bills	58		4. Details for Manufacturers PIN	74
11	Turn Lighting Off	37					1. Wait	58	2	Change Driver PIN	71
							2. Stack Immediately	58	3	Change Operator PIN	71
						9	Cash Discount	58			

## BEVMAX MEDIA – PROGRAMMING MAP SOFTWARE VERSION 10.7.2 KEYPAD

<b>Timed Events</b>									
1	Time of Day Events	77							
	1. Price Adjust	77							
	2. Free Vend	79							
	3. Inhibit	81							
2	Backup Events	82							
3	Power Savings Events	83							
<b>Telemetry</b>									
1	Assign Unit	85							
2	Ping Server	86							
3	Get Network Status	87							
4	Show Network Config	87							
5	Load Network Config	88							
6	Radio Setup	88							
7	How Telemetry Works	91							
8	Definitions	92							
<b>Machine Configuration</b>									
1	Refrigeration Settings	94							
2	Space to Sales	95							
3	Picker Cup Sensor	96							
4	Port Sensor	96							
5	Manual Key Switch	96							
6	Firmware Information	97							
	Cabinet Offsets	97							
	EVS Compliance	97							
	Shelf Location	98							
	Model #	98							
	Encoder Resolution #	98							

**BEVMAX MEDIA – PROGRAMMING MAP  
SOFTWARE VERSION 10.7.2 Touch**

**1. DATA RECALL**.....Press icon to bring up a list.

Press the Data Recall icon brings up a list of the groups in this function.

<b>Data Recall</b>
Non-Resetable Sales Data >
Resetable Sales Data >
Events >
Identification Numbers >

Press the screen to choose a group.

Choosing a group will bring up the first screen in the chosen group.

**1. Non-Resetable Sales Data – Press the icon to bring up a screen**

Press the Non-Resetable icon will bring up a screen listing the sub-groups that contain the data in this group.

TECH TIP – The listings in this group are a running total and will not be reset when a DEX read is done or the “DATA CLEAR” function is used.

<b>Non-Resetable Sales Data</b>
Over-All Totals >
By Tray >
By Product >
Cash >
Cashless >
Bill Data >

Press an icon to choose a Sub-Group.

Choosing a Sub-Group will bring up the first screen in that Sub-Group.

**1. Overall Totals – Press the icon to bring up a table listing data.**

		
<b>Overall Totals</b>		
		#
Sales	\$0.00	0
Discounts	\$0.00	0
Surcharge	\$0.00	0
Test Vend	\$0.00	0
Free Vend	\$0.00	0
Token Vend	\$0.00	0

## BEVMAX MEDIA – PROGRAMMING MAP SOFTWARE VERSION 10.7.2 Touch

2. **By Tray** – Press the icon to bring up a screen listing all trays.  
Press icon to select a tray and you will bring up a screen with a table listing data as shown.

By Tray	
Tray #1	>
Tray #2	>
Tray #3	>
Tray #4	>
Tray #5	>

Tray 1 Data		
		#
Sales	\$0.00	0
Discounts	\$0.00	0
Surcharges	\$0.00	0
Test Vend	\$0.00	0
Free Vend	\$0.00	0

3. **By Product** – Press the icon to bring up a screen listing all trays  
Press an icon to select a tray and you will bring up a screen listing the product selections on that tray.

By Product	
Tray #1	>
Tray #2	>
Tray #3	>
Tray #4	>
Tray #5	>

Tray #1	
101	101>
102	102>
103	103>
104	104>
105	105>
106	106>
107	107>
108	108>
109	109>

Press an icon to select an individual product selection and you will bring up a table listing dollar values and number of vends for that product. This table includes a line to include the Price of the product set in the selection. The date and time of the last vend of the selected product is displayed below the table.

101		
		#
Price	\$0.00	
Sales	\$0.00	0
Discounts	\$0.00	0
Surcharge	\$0.00	0
Test Vend	\$0.00	0
Free Vend	\$0.00	0

**Last Vend**      Date / Time



## BEVMAX MEDIA – PROGRAMMING MAP SOFTWARE VERSION 10.7.2 Touch

4. **Cash** – Press the icon to bring up a table listing Cash Data.

<b>Cash</b>		
		#
Cash In	\$0.00	
To Cash Box	\$0.00	
To Tubes	\$0.00	
Bills In	\$0.00	
Dispensed	\$0.00	
Manual Dispensed	\$0.00	
Sales	\$0.00	0
Discounts	\$0.00	0
Surcharge	\$0.00	0
Over Pay	\$0.00	0

5. **Cashless** – Press the icon to bring up a table listing Cashless Data.

<b>Cashless A</b>		
		#
Sales	\$0.00	0
Discounts	\$0.00	0
Surcharge	\$0.00	0
Revalue	\$0.00	0
<b>Cashless</b>		
		#
Sales	\$0.00	0
Discounts	\$0.00	0
Surcharge	\$0.00	0
Revalue	\$0.00	0

6. **Bill Data** – Press the icon to bring up a table listing Bill Data.  
The contents of the recycler unit have been listed below the table.

<b>Bill Data</b>		
	In	Out
One	\$0.00	\$0.00
Two	\$0.00	
Five	\$0.00	\$0.00
Ten	\$0.00	
Twenty	\$0.00	
Fifty	\$0.00	
Hundred	\$0.00	

**Recycler Contents** \$0.00

## BEVMAX MEDIA – PROGRAMMING MAP SOFTWARE VERSION 10.7.2 Touch

### 2. Resettable Sales Data – Press the icon to bring up a list

Press the icon will bring up a screen listing the sub-groups that contain the data in this group.

TECH TIP – The listings in the resettable group are identical to the listings in the non-resettable group with the exception of the “CLEAR DATA” function which allows the totals to be set back to Zero.

←	🏠	🔑	⏻
Resettable Sales Data			
Overall Totals	>		
By Tray	>		
By Product	>		
Cash	>		
Cashless	>		
Bill Data	>		
Clear Data	>		

Press the icon to choose a Sub-Group.

Choosing a Sub-Group will bring up the first screen in the chosen Sub-Group.

#### 1. Overall Totals – Press the icon to bring up a table listing data.

←	🏠	🔑	⏻
Overall Totals			
			#
Sales	\$0.00		0
Discounts	\$0.00		0
Surcharge	\$0.00		0
Test Vend	\$0.00		0
Free Vend	\$0.00		0
Token Vend	\$0.00		0

#### 2. By Tray – Press the icon to bring up a screen listing all trays.

Press a numeric Key to select a tray and you will bring up a screen with a table listing data as shown.

←	🏠	🔑	⏻
By Tray			
1) Tray #1	>		
2) Tray #2	>		
3) Tray #3	>		
4) Tray #4	>		
5) Tray #5	>		

←	🏠	🔑	⏻
Tray 1 Data			
			#
Sales	\$0.00		0
Discounts	\$0.00		0
Surcharges	\$0.00		0
Test Vend	\$0.00		0
Free Vend	\$0.00		0

## BEVMAX MEDIA – PROGRAMMING MAP SOFTWARE VERSION 10.7.2 Touch

3. **By Product** – Press the icon to bring up a screen listing all trays  
Press an icon to select a tray and you will bring up a screen listing the product selections on that tray.

By Product	
Tray #1	>
Tray #2	>
Tray #3	>
Tray #4	>
Tray #5	>

Tray #1	
101	101>
102	102>
103	103>
104	104>
105	105>
106	106>
107	107>
108	108>
109	109>

Press an icon to select an individual product selection and you will bring up a table listing dollar values and number of vends for that product. This table includes a line to include the Price of the product set in the selection. The date and time of the last vend of the selected product is displayed below the table.

101		
		#
Price	\$0.00	
Sales	\$0.00	0
Discounts	\$0.00	0
Surcharge	\$0.00	0
Test Vend	\$0.00	0
Free Vend	\$0.00	0

**Last Vend**      Date / Time

4. **Cash** – Press the icon to bring up a table listing Cash Data.

Cash		
		#
Cash In	\$0.00	
To Cash Box	\$0.00	
To Tubes	\$0.00	
Bills In	\$0.00	
Dispensed	\$0.00	
Manual	\$0.00	
Sales	\$0.00	0
Discounts	\$0.00	0
Surcharge	\$0.00	0
Over Pay	\$0.00	0

## BEVMAX MEDIA – PROGRAMMING MAP SOFTWARE VERSION 10.7.2 Touch

- Cashless** – Press the icon to bring up a table listing Cashless Data.

Cashless A		
		#
Sales	\$0.00	0
Discounts	\$0.00	0
Surcharge	\$0.00	0
Revalue	\$0.00	0

Cashless B		
		#
Sales	\$0.00	0
Discounts	\$0.00	0
Surcharge	\$0.00	0
Revalue	\$0.00	0

- Bill Data** – Press the icon to bring up a table listing Bill Data.  
The contents of the recycler unit have been listed below the table.

Bill Data		
	In	Out
One	\$0.00	\$0.00
Two	\$0.00	
Five	\$0.00	\$0.00
Ten	\$0.00	
Twenty	\$0.00	
Fifty	\$0.00	
Hundred	\$0.00	

**Recycler Contents** \$0.00

- Clear Data** – Press the icon to clear resettable data.

Press the icon will bring up a screen asking you if you are sure you want to clear the resettable data. Respond by pressing the Yes or No icon.

Do you really want to clear all  
Resettable data?

Yes
No

**This is also the data that is cleared each time the machine successfully transmits a DEX file.**

# BEVMAX MEDIA – PROGRAMMING MAP

## SOFTWARE VERSION 10.7.2 Touch

### 3. EVENTS – Press the icon to bring up a screen

Press the icon will bring up a screen which is divided into two sections.  
The top section of the screen allows you to view recorded data for each type of event.

	
<b>Events</b>	
Power Losses	>
Door Events History	>
Last Data Clear	Date/Time
Last Vend	Date/Time-Selection
Last Price Change	Date/Time
Last Clock Set	Date/Time
Last Health Control Event	Date/Time-Selection

Press the icon to bring up a list for each type of event.

The Last Data Clear data would include both a manual clear and a successful DEX read.

		
<b>Power Losses</b>		
<b>Duration</b>	<b>Date</b>	<b>Time</b>
1 hours 09 minutes	04/24/2013	08:26
0 hours 12 minutes	04/12/2013	17:30

1. **Power losses** – Press the icon to bring up a listing of data about recorded power losses or a message of “No Power Losses” registered

The data is recorded in order of occurrence and can be a valuable diagnostic tool to determine if a power outage is the cause of a reported problem.

2. **Door Events History** – Press the icon will bring up a screen listing data about recorded door events.

		
<b>Door Events History</b>		
<b>Event</b>	<b>date</b>	<b>time</b>
Open Door	###/###/###	00:00:00
Closed Door	###/###/###	00:00:00
Open Door	###/###/###	00:00:00
Closed Door	###/###/###	00:00:00
Open Door	###/###/###	00:00:00
Closed Door	###/###/###	00:00:00

The data is recorded in order of occurrence and can be a valuable tool used to determine if the door has been opened and closed at a time when it should not have been.

# BEVMAX MEDIA – PROGRAMMING MAP SOFTWARE VERSION 10.7.2 Touch

## **4. Identification Numbers – Press the icon to bring up a screen.**

Press the icon will bring up a screen listing the ID numbers for the devices listed or a message “not connected”.

	
<b>Identification Numbers</b>	
Bill Validator	#####
Card Reader	#####
Coin Mechanism	#####

## **2. DIAGNOSTICS.....Press the icon to bring up a screen.**

Press the icon will bring up a screen listing the errors along with the time and date they occurred or a message of “No Errors Registered” will display.

		
<b>Diagnostics</b>		
	time	date
Coin Tube 1 Empty	14:35	04/12/2013
Cabinet not cooling	09:45	03/25/2013
Coin Tube 2 Empty	17:00	02/28/2013

This screen will automatically come up when the service mode is entered if errors

currently exist. You may use the  icon to back up to a previous menu in the service screens.

List of many of the Errors/causes/solutions follow:

<b><u>Error Description</u></b>	<b><u>Probable Cause</u></b>	<b><u>Possible Solutions</u></b>
Stuck Keys Fatal.	Stuck keys on keypad or shorted connections/harness.	Check connectors to be properly installed. Check harness for damage. Replace the keypad.
No Monetary Device Fatal.	The control board has not been able to detect a working monetary device.	Check connectors to be properly installed. Check harness for damage. Check for faulty bill validator/harnessing. Retest without the bill validator and harnessing installed. Replace the coin mechanism.
Coin Mech No Comms.	No Communications are occurring between the coin mechanism and the control board.	Check connectors to be properly installed Check harness for damage Retest without the bill validator and harnessing installed. Replace the coin mechanism.
Coin Mech ROM Error	Coin Mech ROM Error	Replace the coin mechanism.
Coin Mech Acceptor Unplugged.	Coin Mech Acceptor Unplugged.	Check the connections within the coin mechanism Replace the coin acceptor. Replace the coin Mechanism.
Coin Mech Acceptor Jammed.	Coins or other items are stuck in the acceptor causing the gate to remain open.	Remove the coins or other items from the acceptor. Replace the acceptor. Replace the coin mechanism.
Coin Mech Payout Jammed.	Coin pay out motor or solenoid is stuck in cycle.	Check for and remove bent coins or other items causing the jam. Replace the coin mechanism.
Coin Mech Sensor Error.	Bad coin mechanism sensor.	Check for an item causing a blockage and remove. Replace the coin mechanism.
Coin Mech All Tubes Error.	Coin mechanism not sensing any pay out tubes.	Check for proper pay out cassette placement. Replace the payout cassette. Replace the coin mechanism.

<b><u>Error Description</u></b>	<b><u>Probable Cause</u></b>	<b><u>Possible Solutions</u></b>
Coin Mech Tube Error.	Coin mechanism not sensing a payout tube.	Check for proper pay out cassette placement. Replace the payout cassette. Replace the coin mechanism.
Coin Mech Disabled.	Coin mechanism has been disabled by the board	Power down the machine and re-start. Remove bill validator and/or card reader from system. Replace the coin mechanism. Reset the control board. Replace the control board.
Exec Price Error.	Executive coin mechanism error.	Check for a price set outside of allowed parameters. Replace executive coin mechanism.
No Monetary Device.	No monetary device detected by the board.	Check connectors to be properly installed. Check harness for damage. Retest without the bill validator and harnessing installed. Replace the coin mechanism.
Coin Return Motor Not Present.	Control board not sensing the presence of a coin return motor.	Check the connection J6 on the I/O board to the coin return motor. Home the coin return motor. Replace the coin return motor. Check for damage to harnessing. Reset or replace the control board.
Coin Return motor Run Time Timeout.	The board has determined that the coin return motor should have arrived at home position, but it has not.	Check the connections to the coin return motor. Home the coin return motor. Replace the coin return motor. Check for damage to harnessing. Reset or replace the control board.
Coin Return Motor Short Circuit.	Coin return motor has shorted out.	Check connections and harnessing for damage. Replace the coin return motor.
Coin Return Motor Drive Failure.	The coin return motor is not engaging the coin return arm on the coin mechanism.	Check for damaged or missing drive linkage. Check for proper mounting of coin mechanism. Check for damage on coin mechanism pay out parts.



<b><u>Error Description</u></b>	<b><u>Probable Cause</u></b>	<b><u>Possible Solutions</u></b>
Low Change.	The coin mechanism has reported a low or empty condition in one or more of the coin pay out tubes.	Add coins to the tubes using the coins in/out screen in the monetary section of the service modes. Do vends with coins to add coins to the tubes. Replace coin mechanism.
No IO Comm.	The control board is not communicating with the I/O board.	Check for proper connections on the I/O board. Check for proper connections on the control board. Check for damage to the harnessing. Remove the monetary devices from the system and check for restored communication. Replace the I/O board. Reset and/or replace the control board.
Please Wait.	The board is asking you to wait while it completes an ongoing operation.	Wait for the board to finish the operation. Re-start the machine and let it re-boot. Remove monetary devices and re-start the machine. Reset and/or replace the control board.
No Selections Available.	The control board is not sensing any motors available for use.	Check for motors to be homed. Check for motors and harnesses to be connected. Check for power to I/O board. Replace I/O board. Reset and/or replace control board.
All Selections Disabled.	The control board has disabled all the motors in the machine.	Check SureVend settings and operation. Check motors to be homed and connected properly. Check for a timed event to be enabled causing the Condition. Check/replace I/O board. Reset/replace control board.
IO Board Voltage.	The control board has detected improper voltage for I/O board operation.	Check voltage to the machine. Check voltage to the I/O board. Replace the I/O board.
Init Failed.	The control board has failed to initialize successfully.	Power down and re-start the machine. Power down, disconnect monetary devices and re-start the machine. Replace the control board.

<b><u>Error Description</u></b>	<b><u>Probable Cause</u></b>	<b><u>Possible Solutions</u></b>
Health Control Active.	The control board has detected a temperature condition which is outside the allowed parameters and has stopped allowing sales of involved products.	Check for clean screens and condenser. Check for acceptable clearance behind the machine. Check temperature sensor for accurate readings. Check refrigeration system for proper function.
Anti Jackpot Error.	The control board has detected multiple attempts to vend a product from a selection and has not seen a successful delivery.	Check SureVend calibration. Check SureVend function. Check motor function.
# XXX Sold Out.	The control board has determined that a selection is sold out. (XXX indicates the selection number involved).	Check to see that there is product. Check SureVend calibration. Check SureVend function. Check motor function.
Factory Init.	An attempt to restore factory default settings has been unsuccessful.	Power down, power up, try again. Power down, remove monetary devices and try again. Replace the control board and reset.
Card Reader No Comms.	The control board is not able to communicate with the card reader.	Check connections for the card reader. Check for damage to the harness (cut, pinched, etc.). Replace the card reader. Reset the control board. Replace the control board.
Card Reader Comms Error.	The control board is not communicating with the Card reader.	Check the connections and harness for damage. Check the settings on the board and on the reader. Replace the reader. Reset and/or replace the board.
Bill Validator No Comms.	The control board is not communicating with the bill validator.	Check the connections and settings for the validator. Replace the harness. Replace the validator.
Bill Validator Motor Error.	The validator has reported an error to a drive motor within the validator.	Check for a broken belt or blockage. Replace the bill validator.
Bill Validator Sensor Error.	The validator has reported an error to a sensor within the validator.	Check for a sensor blockage. Replace the bill validator.

<b><u>Error Description</u></b>	<b><u>Probable Cause</u></b>	<b><u>Possible Solutions</u></b>
Bill Validator ROM Error.	An error has been detected in a main chip in the Validator.	Replace the bill validator.
Bill Validator Acceptor Jammed.	A jam in the bill path has been detected.	Check the bill path for items that are blocking sensors. Check to see that the bill path gates are not open. Replace the bill validator.
Bill Validator Stacker Error.	An error has been reported concerning the bill box.	Check the bill box to be mounted to the validator properly. Replace the bill box. Replace the bill validator.
Bill Validator Stacker Full.	The bill validator is reporting that the bill box is full of bills.	Check for bills and remove them. Replace the bill box. Replace the bill validator.
Bill Validator Disabled.	The control board has disabled the bill validator.	Check for coins in the payout tubes of the coin Mechanism. Check for a fault with the bill validator.
Check Winner Prize.	The control board has detected a failed winner vend.	Check for the presence of product. Check motor function.
POWER OFF.	The control board has detected a power outage.	Check the power cord and plug. Check the circuit breaker. Check the On/Off switch in the machine.
DOOR OPEN.	The control board is reporting that the door has been opened.	Check to see if someone has been in the machine. Check the door switch. Check switch connections and harnessing for damage.
Power Save mode.	The machine is in a power save event.	Let the event complete. Modify or eliminate the event in the software settings.
Sold Out Machine.	The control board has determined that all selections in the machine are sold out.	Check SureVend settings and function. Check for vend motor function. Check harnessing connections. Check for board function (selection configuration).

<b><u>Error Description</u></b>	<b><u>Probable Cause</u></b>	<b><u>Possible Solutions</u></b>
Recycler Motor Problem.	A problem has been detected with a motor inside the bill validator.	Check for an obstruction or blockage within the recycler which is stopping the motor from completing its cycle. Replace the bill validator.
Recycler Sensor Problem.	A problem has been detected in a sensor within the recycler.	Replace the recycler cassette. Replace the bill validator.
Recycler Jam.	The recycler is unable to function.	Check for an obstruction or blockage which is preventing the recycler from completing its cycle. Replace the recycler cassette. Replace the bill validator.
Recycler Checksum Error.	A communications error has been reported between the recycler and the control board.	Check the bill validator harnessing for damage. Re-start the system to restore communication. Replace the recycler.
Recycler Disabled.	The recycler has been disabled by the control board.	Check for proper function of the recycler unit (errors). Check the recycler cassette for proper installation. Replace the bill validator.
# XX Coin Mech Tube Empty.	The coin mechanism is reporting that there is an empty payout tube. (# XX indicates which tube is empty).	Check for an empty tube and replenish. Check for a bad sensor. Replace the coin cassette. Replace the coin mechanism.
Bill Validator Stacker Motor Error.	An error has been reported concerning the stacker Motor in the bill validator.	Check the bill path for a blockage preventing the proper operation of the bill stacker motor. Replace the bill validator.
Bill Validator Recycler Gate Error.	An error has been detected in the recycler gate	Check for an blockage in the bill path preventing the gate from functioning. Replace the bill validator.
Bill Validator Recycler Tape Error.	An error has been reported in the operation of the recycler tape within the recycler cassette.	Check for a blockage in the bill path which prevents the tape from moving backward and/or forward. Replace the recycler cassette. Replace the bill validator.

<b><u>Error Description</u></b>	<b><u>Probable Cause</u></b>	<b><u>Possible Solutions</u></b>
Optical Sensor Failure.	The failure of an optical sensor within the bill validator has been detected.	Check the bill path for an obstruction or blockage which prevents the optical sensor from functioning. Replace the bill validator.
Magnetic Sensor Failure.	The failure of the magnetic sensor within the bill validator has been detected.	Check the bill path for an obstruction or blockage which prevents the magnetic sensor from functioning. Replace the bill validator.
Recycler Cass Jammed.	The recycler cassette is not able to move.	Check for an obstruction or blockage which is preventing the cassette from moving. Replace the recycler cassette. Replace the bill validator.
Bill Validator Path Jammed.	A blockage of the bill path has been reported.	Check for an obstruction or blockage which is preventing the bills from moving thru the bill validator. Replace the bill validator.
Bill Validator Cashbox jammed.	The bill box has become jammed and is not allowing the stacker motor to complete its cycle.	Check for a full bill box Check for damaged bills blocking the operation of the stacker plate. Replace the bill box. Replace the bill validator.
Stacker Out Of Position.	The control board has detected that the stacker has stopped out of its home position.	Check for a blockage or obstruction which is not allowing the stacker motor to complete its cycle. Check for proper installation of the bill box. Replace the bill box. Replace the bill validator.
Recycler Out Of Position.	The recycler is not able to accept bills.	Check for proper installation of the recycler cassette. Check for an obstruction or blockage which is preventing the cassette from locking into position. Replace the recycler cassette. Replace the bill validator.

<b><u>Error Description</u></b>	<b><u>Probable Cause</u></b>	<b><u>Possible Solutions</u></b>
X Motor Failure.	The control board is reporting that the X motor is not functioning.	Check for proper connections to the motor. Check for damage to the harnessing. Check for proper switch function. Check for over tightening of the motor. Replace the motor.
Y Motor Failure.	The control board is reporting that the Y motor is not functioning.	Check for proper connections to the motor. Check for damage to the harnessing. Check for proper switch function. Check for over tightening of the motor. Replace the motor.
Picker Motor Failure.	The control board is reporting that the picker motor is not functioning.	Use the position test functions to test the picker motor. Replace the picker cup.
Port Motor Failure.	The control board is reporting that the port motor is not functioning.	Use the port test functions to test for function Check wiring connections. Check switch functions including the position cam. Replace the motor.
Vend Timeout.	The control board is reporting that a successful vend cycle has not been completed in the allowed amount of time.	Check for a picker cup that did not return to the home position. Check for a port door that did not open/close."
Cabinet Failure.	An error that has not yet been defined.	Should not be seen in a machine. Replace the control board.
Coin Return Motor Failure.	The control board is reporting that the coin return Motor has failed.	Check the wiring connections. Check for proper mounting of the motor. Check for proper mounting of the coin mechanism. Replace the coin return motor.
Picker Home Failure.	The control board has reported that the picker has failed to return to its home position at the end of a cycle.	Use the position test functions to test or cycle the picker back to its home position. Replace the picker cup.
Temperature Sensor Error.	The control board is reporting that the temperature sensor has failed.	Compare the reported temperature against a Thermometer. Replace the temperature sensor.

<b><u>Error Description</u></b>	<b><u>Probable Cause</u></b>	<b><u>Possible Solutions</u></b>
Cooling System Not Cooling.	The control board is reporting that the refrigeration system is not functioning.	Check for a bad temperature sensor. Check for other errors that would cause the refrigeration system to have been shut down by the board.
Cabinet Too Hot.	The control board is reporting that the cabinet is operating at three degrees, or more, above the allowed parameter.	Check for an accurate temperature reading. Check refrigeration system for proper function (clean screens, condenser also distance from rear wall). Check for proper fan operation.
Cabinet Too Cold.	The control board is reporting that the cabinet is operating at three degrees, or more, below the allowed parameter.	Check for an accurate temperature reading. Check refrigeration system for proper function (clean screens, condenser also distance from rear wall). Check for proper fan operation.
Card Reader Manuf Trans Error.	The card reader has reported an error in transmitting data.	Check the card reader for proper function. Replace the card reader.
Card Reader Service Error.	An internal error has occurred within the card reader.	Reset the card reader and retry. Replace the card reader.
Card Reader Manufact Error.	An internal error has occurred within the card reader.	Reset the card reader and retry. Replace the card reader.
Card Reader Failed OOS Error.	An internal error has occurred within the card reader.	Reset the card reader and retry. Replace the card reader.
Card Reader Comms OOS Error.	An internal error has occurred within the card reader.	Reset the card reader and retry. Replace the card reader.
Card Reader Jam OOS Error.	An internal error has occurred within the card reader.	Reset the card reader and retry. Replace the card reader.
Card Reader Manufact OOS Error.	An internal error has occurred within the card reader.	Reset the card reader and retry. Replace the card reader.

<b><u>Error Description</u></b>	<b><u>Probable Cause</u></b>	<b><u>Possible Solutions</u></b>
Health Check Error.	The control board is reporting that an error occurred in the process of conducting a health check.	Check temperature sensors for proper function. Check the refrigeration system for function. Reset machine for another cool down period to check for proper health control function. Reset the control board to default settings and set up for another test. Replace the control board and re-test.
Heath Timer Error.	The control board is reporting that an error has occurred in the operation of the timer during a health check function.	Reset machine for another cool down period to check for proper health control function. Reset the control board to default settings and set up for another test Replace the control board and re-test.
Health Recheck Error.	The control board is reporting that an error occurred in the process of conducting a second attempt at a health check.	Check temperature sensors for proper function. Check the refrigeration system for function. Reset machine for another cool down period to check for proper health control function. Reset the control board to default settings and set up for another test. Replace the control board and re-test.
Capacity Sensor Failure.	An error has been reported with a sensor inside the bill validator.	Re-start the bill validator and check function. Replace the bill validator.
Not Calibrated Sensor Error. Bill validator.	An error has been reported with a sensor inside the	Re-start the bill validator and check function. Replace the bill validator.
X Motor Home Failure	The X motor home switch is not detected.	Check XY Assy is all the way to the left at the top. Replace the X Home Switch. Replace the Atlas Board.
Y Motor Home Failure	The Y motor home switch is not detected.	Check XY Assy is all the way to the left and Delivery Cup is all the way to the bottom. Replace the Y Home Switch. Replace the Y Board. Replace the Atlas Board.



<b><u>Error Description</u></b>	<b><u>Probable Cause</u></b>	<b><u>Possible Solutions</u></b>
Picker Home Failure	The picker home switch is not detected.	<p>Check the plunger is all the way in at the home position.</p> <p>Replace the Picker Home Switch.</p> <p>Replace the Delivery Cup Assy.</p> <p>Replace the Y Board.</p> <p>Replace the Atlas Board.</p>
Port Open Error	The port closed switch is not detected.	<p>Check the port door is all the way closed.</p> <p>Replace the Port Closed Switch.</p> <p>Replace the Port Assy.</p> <p>Replace the Atlas Board.</p>

### 3. TEST.....Press the icon to bring up a screen.

Press the icon will bring up a screen listing the functions within the group.

	
<b>Test</b>	
Test Vend	>
Coin Return Motor	>
Surround Lighting Test	>
Screen Test	>
Refrigeration Test	>
MagTeck Head Test	>
Cashless system test	>
Monetary	>
Port and Cup Sensors	>
Platform Movement	>
Turn Lighting Off	>

Press the icon to choose a function.

Use the top arrow and bottom arrow on the right side of the screen to scroll through the multiple screens if needed.

Choosing a function will bring up the first screen within each function.

#### 1. Test Vend – Press the icon will bring up a screen.

	
<b>Test Vend</b>	
Credit	\$0.00
Credit Card	
Token	
<b>Select Product</b>	
Select Product	101
Price	\$0.00
Start Vend	>

Insert coins, bills or tokens to increase credit amount. If an MDB cashless device is present or the onboard cashless interface is used in the machine, the user may swipe a card to establish credit to test function.

Press the Select product icon opens a window allowing you to enter another selection using the numeric icons. Press the “Done” icon to save. Press the “Start Vend” icon to run the selected motor. Note: The left door switch must be pulled to the out position for the XY to move.

#### 2. Coin Return Motor – Press the icon to activate the test.

Press the icon will run one cycle on the coin return motor and display will show a success message if motor runs.

	
<b>Test</b>	
Test Vend	>
Coin Return Motor	>
	Success
Surround Lighting Test	>
Screen Test	>

**3. Surround Lighting Test – Press the icon to enter the function.**

Press the icon brings up a screen listing one option.



Press the icon to perform the test. The display will say “Surround Lights should change now” and the integrated payment openings lights will turn on, change colors, and turn off, then the pill light tube will turn on, change colors, then turn off.

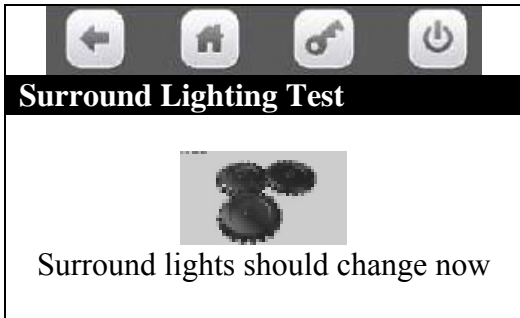

**4. Screen Test – Press the icon to enter the function.**

Press the icon will bring up a screen with four colored bands which get progressively brighter.



The colors from left to right are Red, Green, Blue and at the bottom White.

**5. Refrigeration System – Press the icon to enter the function**

Test	
Return Air	71°F
Refrigeration State	0
Turn Compressor On	>
Turn Evaporator Fan On	>

Press the icon will bring up a screen which displays the data listed.

Return Air is the temperature of the air inside the vender. Refrigeration State is an unused field and does not represent anything.

Turn Compressor On, if you press icon it will toggle to off. At this state the compressor is On or running.

Turn Evaporator Fan On, if you press icon it will toggle to off. At this the fan is On or running.

**6. MagTeck Head Test – Press the icon to enter the function.**

Press the icon will bring up a screen and the top portion is asking you to swipe your card.

<b>MagTeck Head Test</b>	
Please swipe card	
Good / Bad Swipes	0 / 0
<b>Last Swipe Information</b>	
Track 1	0
Track 2	0
Track 3	0

Swiping your card will tell you if it was a good or bad swipe and on which tracks data was detected.

**7. Cashless system test – Press the icon to enter the function.**

Press the icon will bring up a screen and the top portion will read “Please Swipe Card”. The bottom of the screen will tell you the most recent swipe status.

<b>Cashless system test</b>	
Please swipe card	
<b>Most recent swipe status</b>	

**8. Monetary – Press the icon to bring up a screen.**

Press the icon will bring up the screen that shows data about the coin mechanism and the bill validator.

When there are empty columns with no column header, it simply means we are using a pre-built Flash table. It provides room for future data to be inserted.

If no Mech or Validator is detected the screen will show a message. Example - Error: no bill validator detected. Please attaché one and enable it in Money menu.

<b>Monetary</b>		
<b>Coin Mechanism</b>		
<b>Coin</b>		
\$0.05		
\$0.10		
\$0.25		
<b>Bill Validator</b>		
\$1.00		
\$5.00		
Token		

**9. Port and Cup Sensors – Press the icon to bring up a screen.**

Port and Cup Sensors		
<b>Port Sensor</b>		
Sensor	off	
Vend detect	off	
Port Open Switch	off	
Port Closed Switch		on
Turn Port Sensor On		>
Open Port		>
<b>Picker Cup Sensor</b>		
Sensor	off	
Vend Detect	off	
Picker Motor Home		on
Picker Motor out	off	
Turn Cup Sensor On		>
Cycle Cup Plunger		>

Data lists the current state concerning the Port Sensor.

Use the icon to Change the state concerning the Port Sensor.

Data lists the current state concerning the Picker Cup Sensor.

Use the icon to Change the state concerning the Cup Sensor.

**10. Platform Movement – Press the icon to bring up a screen.**

Press the icon will bring up a screen allowing you to turn the components on and off.

Platform Movement		
X Home		On
Y Home		On
Picker Motor Home		On
Picker Motor out	Off	
Port Open	Off	
Port Close		On
Door Switch	Opened	
Motor Positions	10005	9919
<b>Select '0' to 'home' the platform</b>		
Move to Selection		0
Cycle Cup Plunger		>

Data listed is showing the current state of the various switches as seen by the machine.

Motor positions: number on right is vertical motor counts; number on left is horizontal motor counts.

Press the Move to Selection icon opens a window allowing you to enter a selection number using the numeric icons. Press the “Done” icon to move XY to the selection. Press the “Cycle Cup Plunger” icon to cycle the plunger and

vend product from the column selected. Note: The left door switch must be pulled to the out position for the XY to move & plunger to cycle. Press the Move to Selection icon opens a window allowing you to enter a selection number using the numeric icons. Enter “0”, and then press the “Done” icon to move XY to the home position.

**11. Turn Lighting Off – Press the icon to bring up a screen.**

Press the icon will bring up a screen allowing you to turn the Vertical Lighting on and off.



Press the icon will toggle the state of the Vertical Lights between On and Off.

Note: The top LEDs are not controlled by this switch.

**4. PRICE ..... Press the icon to bring up a pricing screen.**

Pricing of selections can be accomplished in three ways with the pricing screen open.



**BY TRAY**

Press an icon, to select a Tray (1 to 5) and a window will open allowing you to enter a new price.

Press the numeric icons to enter a new price for all selections on the selected tray.

Press the “Done” icon to accept the new pricing.

**BY ENTIRE MACHINE – Press the icon to enter Price for Entire Vender.**

Press the icon to select Entire Machine, and a window will open allowing you to enter a new price using the numeric icons. Press the “Done” icon to accept the new pricing.



**BY INDIVIDUAL SELECTION – Press the icon to enter Price for Individual Selection.**

Press the icon to select Individual Prices and a tray list will come up.

	
<b>Individual Prices</b>	
Tray 1	>
Tray 2	>
Tray 3	>
Tray 4	>
Tray 5	>

Press an icon to select a tray and you will bring up a screen listing the product selections on that tray.

	
<b>Tray #1</b>	
101	\$0.00
102	\$0.00
103	\$0.00
104	\$0.00
105	\$0.00
106	\$0.00
107	\$0.00
108	\$0.00
109	\$0.00

Press an icon to choose a selection will open up a window allowing you to enter a new price.

Press the numeric Key icons to enter a new price for the chosen selection.

Press the “Done” icon to accept the new pricing.

**5. PRODUCT CONFIGURATION .....Press the icon to bring up a screen.**

Press the icon brings up a screen listing the various functions.

	
<b>Product Configuration</b>	
Selection Configuration	>
FIFO Setup	>
UPC/EAN Codes	>
Shopping Cart Setup	>
View Planogram	>

Press an icon will bring up the first screen in the function selected.

**1. Selection Configuration – Press the icon to bring up a screen.**

Press the icon will bring up a screen with a tray list.

	
<b>Selection Configuration</b>	
Tray #1	>
Tray #2	>
Tray #3	>
Tray #4	>
Tray #5	>

Use the icon to choose a tray and bring up a screen listing the selections on the chosen tray.

	
<b>Tray #1</b>	
101	✓
102	✓
103	✓
104	✓
105	✓
106	✓
107	✓
108	✓
109	✓

Check marks will indicate the active selections.

Use the numeric icons to check or un-check selections as needed.



When selections are complete press the  to return to Selection Configuration, Tray selections screen.

**2. FIFO Setup – Press the icon to bring up a screen.**

	
<b>FIFO Setup</b>	
Add Group Menu	>
Delete Group	>
Edit FIFO Group	>
FIFO Mappings	>

This screen will only show Add Group Menu if no Groups have been created. It will be expanded to include options in grey after a group is added. Press the Add Group Menu icon to add a group.

**1. Add Group Menu - Press the icon to bring up a screen to create group(s).**

	
<b>Add Group Menu</b>	
Create Group	nothing selected
<b>Trays</b>	
Tray #1	>
Tray #2	>
Tray #3	>
Tray #4	>
Tray #5	>

The Tray icons are used to add a group of selections that will operate in FIFO mode. Included selections will be listed on the right side of the Create Group window.

**Once the selections have been added to the group, It must be saved by pressing the Create Group icon to create the group, or your work will be lost!**

Selecting a tray will bring up a screen that will allow you to choose selections that will be included in the group. A group can include selections on more than one tray.



<b>Tray</b>	
Set All	>
Clear All	>
<b>101</b>	
101	√
102	√
103	√
104	√
105	√
106	√
107	√
108	√
109	√

Press the Set All icon will include all selections on the tray in the group. A check will appear for each selection. Press the Clear All icon will remove all selections on the tray from the group. All checks for selections will disappear.

Press an icon for an individual selection will check or un-check that selection. Checks will appear for selections included in the group and disappear for selections not included in the group.

Use the top arrow and bottom arrow on the right side of the screen to scroll through the multiple screens if needed.

**Once the selections have been added to the group, It must be saved by pressing the Create Group icon to create the group, or your work will be lost!**

**Once a group has been created, the original screen will be expanded to include more functions for managing the FIFO operations.**

<b>FIFO Setup</b>	
Add Group Menu	>
Delete Group	>
Edit FIFO Group	>
FIFO Mappings	>

2. **Delete Group** – Press the icon to bring up a screen listing the existing groups.

<b>Delete Group</b>	
Delete Group #1	>
Delete Group #2	>
Delete Group #3	>

Use the icon to select the group to be deleted and a screen will come up asking if you are sure you want to delete the group.

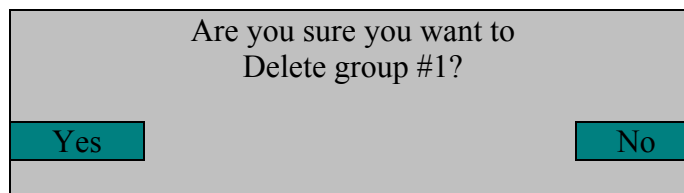

Respond using the Yes/No icons.

Once a selection is made a screen will come up reminding you prices will remain the same as they were set in the FIFO group settings.

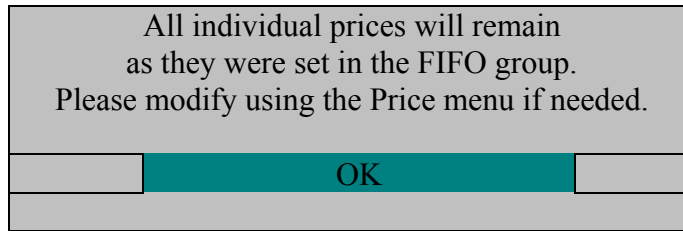

3. **Edit FIFO Group** – Press the icon to bring up a screen listing the existing groups that you or others have created.



Use an icon to choose a group to be edited and a screen will come up which will allow you to edit the chosen group.

Use the Save Group icon to save the changes made to the group.

**If you do not save the changes you make by pressing the Save Group icon, your work will be lost!**

Use the icons to select a tray to edit.

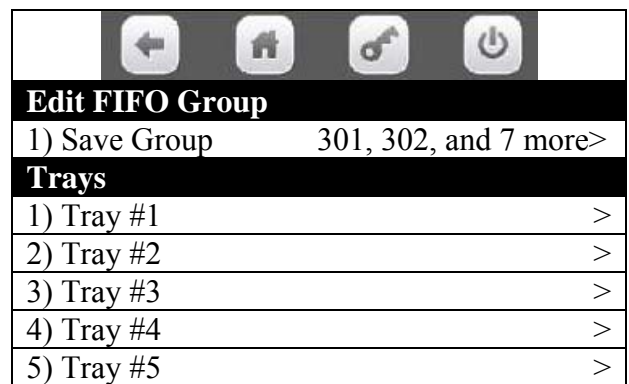

Once a tray is selected a screen will come up that will allow you to edit all the selections on that tray.

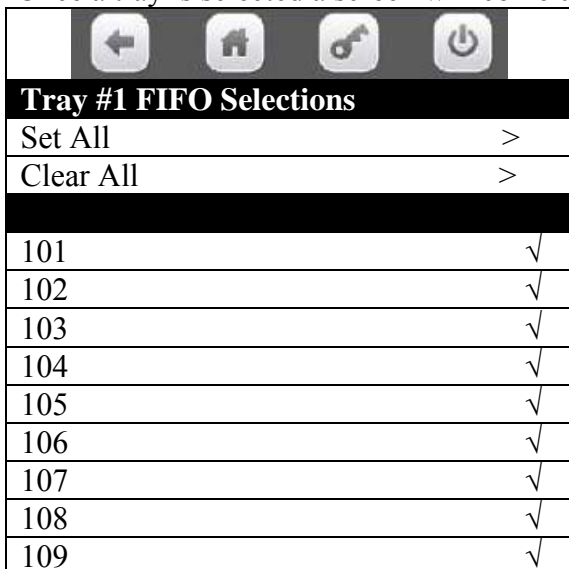

Press the Set All icon will include all selections on the tray in the group. A check will appear for each selection. Press the Clear All icon will remove all selections on the tray from the group. All checks for selections will disappear.

Press an icon for an individual selection will check or uncheck that selection from the group. Checks will appear and disappear for the chosen selection.

When selections are complete press the  to return to Edit FIFO Group and press the Save Group icon to save changes.

**If you do not save the changes you make by pressing the Save Group icon, your work will be lost!**

Use the top arrow and bottom arrow on the right side of the screen to scroll through the multiple screens if needed.

**Remember to return to the screen with “SAVE GROUP” icon; press the Save Group icon to save the changes you have made to the group or your changes will be lost!**

4. **FIFO Mappings** – Press the icon to bring up a tray list.

Use an icon to bring up a list of the selections on the selected tray.

	
<b>FIFO Mappings</b>	
Tray #1	>
Tray #2	>
Tray #3	>
Tray #4	>
Tray #5	>

	
<b>Tray # 2 FIFO Selections</b>	
201	Group #1
202	Group #1
203	Group #1
204	unassigned
205	unassigned
206	unassigned
207	unassigned
208	unassigned
209	unassigned

The selection list will tell you what group each selection is assigned to, or that it is unassigned.

Some selection lists use more than one screen. Use the top arrow and bottom arrow on the right side of the screen to scroll through the multiple screens if needed.

4. **UPC (Universal Product Codes)/EAN(Article Numbering System) Codes** – Press the icon to bring up a list.

	
<b>UPC/EAN Codes</b>	
Clear all Products	>
Tray #1	>
Tray #2	>
Tray #3	>
Tray #4	>
Tray #5	>

Press the icon will bring up a tray list of UPC/EAN Codes.

Press an icon to choose a tray. Choosing a tray will bring up a screen listing all the selections on that tray.

<b>Tray #2</b>	
Clear all Products	>
201	201
202	202
203	203
204	204
205	205
206	206
207	207
208	208
209	209

The “UPC/EAN Code” will be listed on the same line as the selection. The code is the same as the selection number.

Press the numeric icons for a selection will open a window that will allow you to set another code number for that selection using the numeric keypad.

All UPC/EAN codes are numeric only, you cannot enter letters.

You can use the “Shopping Cart” button to delete a character.

Press the “Done” icon to accept the changes to the code, or use the X icon to back out.

Some selection lists use more than one screen. Use the top arrow and bottom arrow on the right side of the screen to scroll through the multiple screens if needed.

**4. Shopping Cart Set-Up – Press the icon to bring up a list.**

Press the icon brings up a screen listing two options for setting up the shopping cart function.

<b>Shopping Cart Setup</b>	
Shopping cart size	3
Max Fund Amount	\$0.00

1. **Shopping Cart Size** – Press the icon opens a window allowing you to set the maximum number of items to be placed in the shopping cart so they can be purchased in one transaction.

<b>Shopping Cart Setup</b>	
1) Shopping cart size	3
2) Max Fund Amount	\$0.00

Use the numeric icons to edit the number of items that may be placed in the cart. The maximum number of items that can be placed in the cart is eight (8).

Use the “Done” icon to accept the change.

2. **Maximum Fund Amount** – Press the icon opens a window allowing you to set the maximum value of items placed in the shopping cart.



The recommended value should be calculated by multiplying the number of items allowed in the cart by the highest price set in the machine.

Use the numeric icons to edit the value of the items.  
Use the “Done” icon to accept the change.

**5. View Planogram – Press the icon to bring up a tray list.**

Press the icon will bring up a tray list.

101	102	103	104	105	106	107	108	109
101	102	103	104	105	106	107	108	109
\$0.00	\$0.00	\$0.00	\$0.00	\$0.00	\$0.00	\$0.00	\$0.00	\$0.00
201	202	203	204	205	206	207	208	209
201	202	203	204	205	206	207	208	209
\$0.00	\$0.00	\$0.00	\$0.00	\$0.00	\$0.00	\$0.00	\$0.00	\$0.00
301	302	303	304	305	306	307	308	309
301	302	303	304	305	306	307	308	309
\$0.00	\$0.00	\$0.00	\$0.00	\$0.00	\$0.00	\$0.00	\$0.00	\$0.00
401	402	403	404	405	406	407	408	409
401	402	403	404	405	406	407	408	409
\$0.00	\$0.00	\$0.00	\$0.00	\$0.00	\$0.00	\$0.00	\$0.00	\$0.00
501	502	503	504	505	506	507	508	509
501	502	503	504	505	506	507	508	509
\$0.00	\$0.00	\$0.00	\$0.00	\$0.00	\$0.00	\$0.00	\$0.00	\$0.00

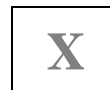

The tray list will show you the selections on the tray along with the product codes and prices. Press the **X** (delete) icon to back out.

Custom Planograms can be downloaded in the machine from a memory (USB) stick.

## 6. SPECIAL VEND MODES .....Press the icon to bring up a screen.

Press the icon will bring up a screen listing all of the functions that can be accessed within this group.

<b>Special Vend Modes</b>	
Free vend	Off
Winner Mode	>
Combo Vends	>
Token Enabled	>
Rapid Vend	No
MultiVend Discount	>

Use the icons to choose a function.

Use the icon to toggle between On and Off for the Free Vend function.

Choosing a function will bring up the first screen of the chosen function.

### 1. Free vend – Press the icon.

Press the icon will toggle an entry in a window on the first screen between On and Off.

<b>Special Vend Modes</b>	
1) Free vend	Off

### 2. Winner Mode – Press the icon to bring up a screen.

Press the icon will bring up a screen that will prompt you to press the Add Group icon.

<b>Winner Mode</b>	
Add Group	>

**This screen has only one option at this point.**

Once a group has been created, this screen will be expanded to include more options for control and editing of the group.

Press the icon will bring up a screen allowing you to create a group of selections to operate in the Winner Mode. It is divided into multiple sections.

- The Add New Winner Group icon is used to save the group you create. If you fail to save the group you create, your work will be lost!**

Press the Mode icon allows you to toggle the setting between Winner and Prize. If Winner is selected, the chosen product is given and credit returned. If Prize is selected, the chosen product is given and a second product (the Prize) is also given.

Press the Frequency icon allows you to determine the frequency or how often a Winner Vend happens, based on the number of successful vends completed. Press the numeric icons to set the number of vends. Press the “Done “ icon to save the number set.

<b>Add Group</b>	
Add New Winner Group	nothing selected
<b>Parameters</b>	
Mode	Prize
Frequency	100
Prize	101
<b>Trays</b>	
Tray #1	>
Tray #2	>
Tray #3	>
Tray #4	>
Tray #5	>

**The Prize icon only appears if the Prize Setting has been chosen in the Mode menu.**

Press the Prize icon will open a live window allowing you to enter the selection number for the product that will be given as a Prize in a winner vend, using the numeric icons. Press the “Done” icon to save the number set.



Tray #2 Winner Selections	
Set All	>
Clear All	>
201	✓
202	✓
203	✓
204	✓
205	✓
206	✓
207	✓
208	✓
209	✓

The last section of the screen is a tray list. Use an icon to choose a tray. The icons will vary depending on your previous choice of Winner or Prize.

Choosing a tray will bring up a screen that displays the selections on the chosen tray. There is a second screen.

Use the Set All icon to include all the selections on the tray in the group. Use the Clear All icon to remove all selections on the tray from the group.

Use the selection icons to check or un-check the selections to be included or removed from the group. Checked selections are the selections included in the group. Some selection lists use more than one screen. Use the top arrow and bottom arrow on the right side of the screen to scroll through the multiple screens if needed.



Use the  to leave one tray so that you can enter another. Selections can be chosen for a group from all trays.

**Once all your choices have been entered, you MUST return to Add New Winner Group icon on the screen and press it to save the group. This will save all your choices and create a group. If you fail to save the data for your group, the data will be lost!**

Once a group has been created, the original screen will be expanded to include more functions for managing the Winner Mode function.

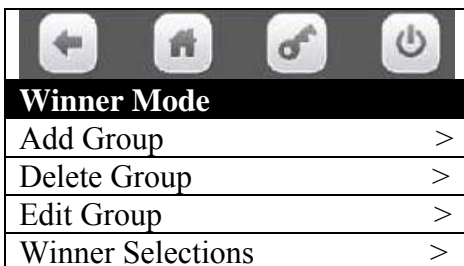

Winner Mode	
Add Group	>
Delete Group	>
Edit Group	>
Winner Selections	>

2. **Delete Group** – Press the icon to bring up a screen listing the existing groups.



Use the icons to select the group to be deleted and a screen will come up asking if you are sure you want to delete the group.

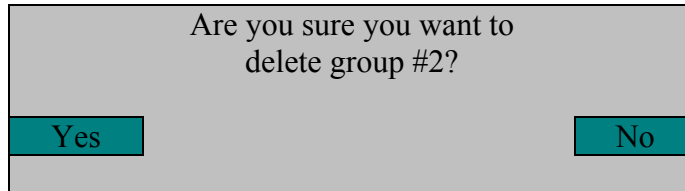

Respond using the Yes or No icon.

3. **Edit Group** – Press the icon to bring up a screen listing the existing groups.



Use an icon to choose a group to be edited and a screen will come up which will allow you to edit the group.

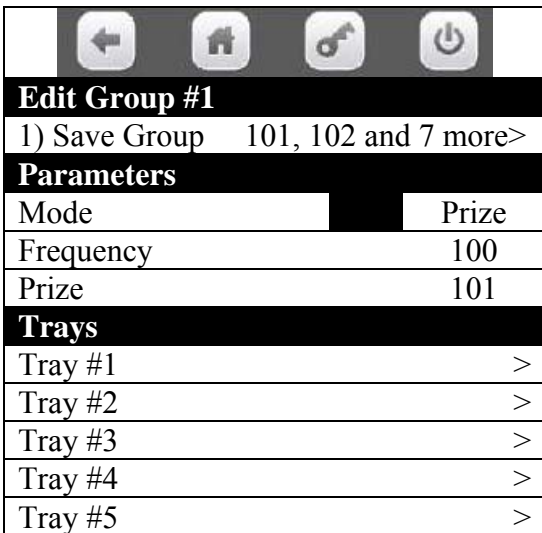

Use the Save Group icon to save the changes made to the group.

Use the icon to select a tray to edit. Once a tray is selected a screen will come up that will allow you to edit all the selections on that tray.

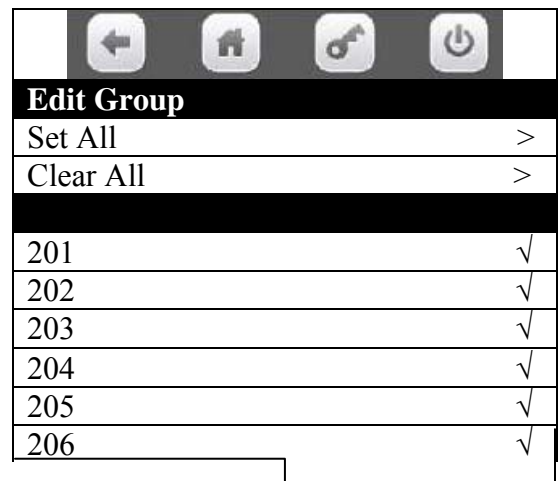

Press the Set All icon will include all selections on the tray in the group. A check will appear for each selection.

Press the Clear All icon will remove all selections on the tray from the group. All checks for selections will disappear.



Press an icon for an individual selection will include or remove that selection from the group. Checks will appear and disappear for the chosen selection.

Some selection lists use more than one screen. Use the top arrow and bottom arrow on the right side of the screen to scroll through the multiple screens if needed.

Checked selections are included in the Group.

**When you have finished Editing, you MUST return to the screen with “SAVE GROUP” and press the Save Group icon to save the changes you have made to the group. If you fail to save your changes, the changes will be lost!**

**4. Winner Selections Mappings – Press the icon to bring up a screen.**

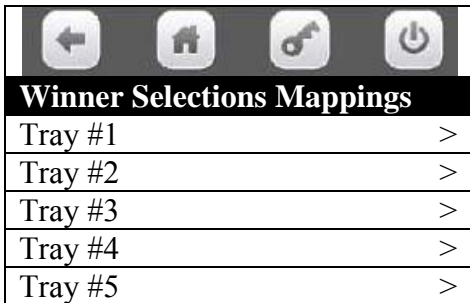

The screenshot shows a mobile application interface with a navigation bar at the top containing icons for back, home, key, and power. Below the navigation bar is a title bar labeled "Winner Selections Mappings". The main content area is a list of five trays, each with a right-pointing chevron icon:

Winner Selections Mappings	
Tray #1	>
Tray #2	>
Tray #3	>
Tray #4	>
Tray #5	>

Press the icon will bring up a screen listing all the trays.

Use an icon to choose a tray.

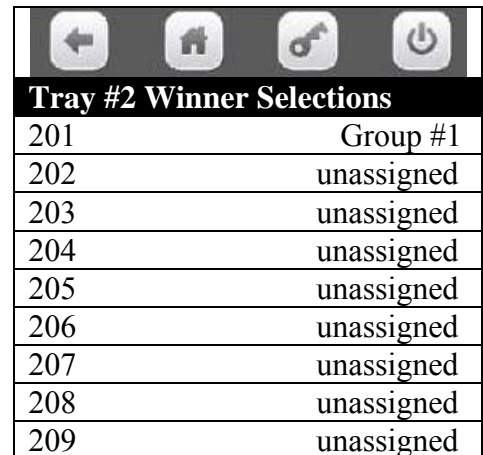

The screenshot shows a mobile application interface with a navigation bar at the top containing icons for back, home, key, and power. Below the navigation bar is a title bar labeled "Tray #2 Winner Selections". The main content area is a list of 9 items, each with a right-pointing chevron icon:

Tray #2 Winner Selections	
201	Group #1
202	unassigned
203	unassigned
204	unassigned
205	unassigned
206	unassigned
207	unassigned
208	unassigned
209	unassigned

Choosing a tray will bring up a list of the selections on that tray.

The right side of the selection list will tell you what group each selection is assigned to, or that it is unassigned.

**3. Combo Vends – Press the icon to bring up a screen.**

Press the icon will bring up a screen listing two options.

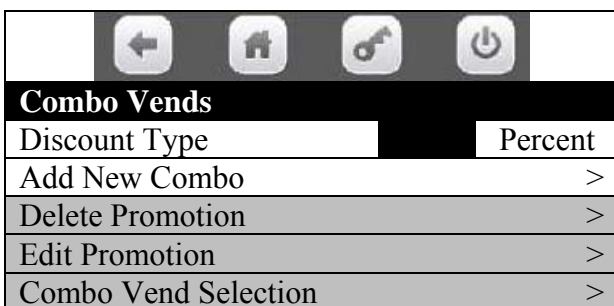

The screenshot shows a mobile application interface with a navigation bar at the top containing icons for back, home, key, and power. Below the navigation bar is a title bar labeled "Combo Vends". The main content area is a list of options, with the first two options highlighted in grey:

Combo Vends	
Discount Type	Percent
Add New Combo	>
Delete Promotion	>
Edit Promotion	>
Combo Vend Selection	>

1. Press the Discount Type icon will toggle the setting in a window between Value and Percent. This will set the way the discount is used, either a set monetary amount (value) or as a percentage of the purchase.

Press the Add New Combo icon will bring up a screen allowing you to create a new combo group.

**Once a group has been created, the original screen will be expanded to include more options for control and editing of the group. See in grey above.**

	
<b>Add New Combo Promotion</b>	
Add New Combo Promotion	
Groups Not Selected>	
Number of Groups in Promotion	2
Discount Percentage	0
Discount All	No
Edit Group 1	0 Selected>
Edit Group 2	0 Selected>
Enable Custom Message	Yes
Message (only visible when Enable is set to Yes)	

**The Add New Combo icon is the save button for your Combo. If you fail to save the combo you create, your work will be lost!**

1. Press the Add New Combo icon once you have created it. **If you do not use this icon to SAVE YOUR WORK after you are done with all the other settings, your work will be lost!**

Note: this functionality is available as long as you have selections assigned to the combo groups.

2. Press the Number of Groups in Promotion icon will toggle the active setting in the window between 2 and 3 Number of Groups in the Combo Promotion. This setting determines the number of groups of products that will be involved in the Combo.

- A. The 2 setting will involve two groups of products.  
Example – (Chips, Candy Bar)
- B. The 3 setting will involve three groups of products.  
Example – (Chips, Candy Bar, Cold Drink)

If 3 setting is selected, an additional line will appear further down in your screen. It will have the title of “Edit Group 3” and show the number selected as do the other two groups. The icons for the functions below will also shift to reflect the additional line.

3. Press the Discount Percentage icon will open a window that will allow you to enter a Discount Percentage for the promotion using the numeric icons. Press the “Done” icon to accept the new number.

4. Press the Discount All icon will toggle the active setting in the window for Discount All between Yes and No.

- A. Selecting YES will apply the discount to each of the items in the Combo.
- B. Selecting NO will apply the discount to only the last item in the Combo.

5. Press the icon to Edit Group1 will bring up a tray list.

- A. Choosing a tray icon will bring up a screen listing all the selections on that Tray . The list has more than one screen.
- B. The checked selections are the selections that are currently included in the group.
- C. Use the numeric icons to check or un-check selections as needed.

6. Press the icon to Edit Group 2 will bring up a tray list

- A. The editing of Group 2 is the same as for Group1.

7. Press the icon to Edit Group 3 (if Number of Groups in was set to 3) will bring up a tray list.

- A. This option will only appear if the three group setting has been chosen previously with the Number of Groups in Promotion menu.
  - B. The editing for Group 3 is the same as for Group1.
8. Pressing the “Enable Custom Message” icon will toggle the setting in the live window between Yes and No. When Yes is selected, an additional line will appear at the bottom of the screen titled “Message”.
9. Press the icon for “Message” will open a live window allowing you to enter a custom message using a alpha numeric keypad.

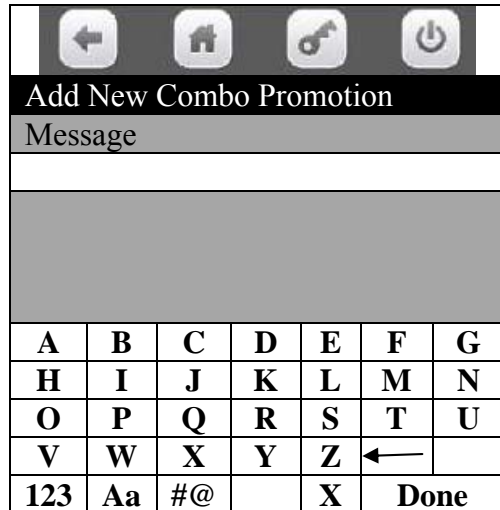

Press the icons on the display to cycle between alpha (upper case & lower case) and numeric (123) characters. Once your message is complete, press the “Done” icon to save message.

**Once a group has been created, the original screen will be expanded to include more options for control and editing of the group.**

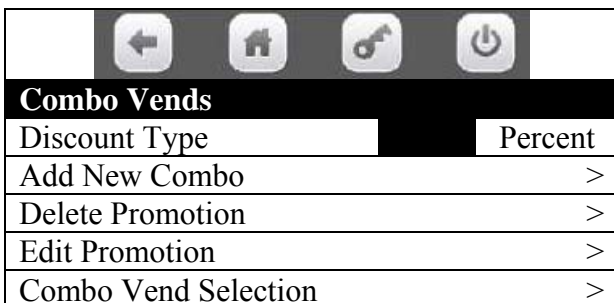

Press the Discount Type icon will toggle the setting in a window between Value and Percent.

This will set the way the discount is used, either a set monetary amount or as a percentage of the purchase.

**Press the Add New Combo** will bring up a screen allowing you to create Another New Combo group. The new Combo Group will be created in the same way as the first, with all the same rules in effect.

**Press the Delete Promotion icon** will bring up a screen listing the existing groups that can be deleted.



Use the Yes or No icon to select the group to be deleted and a screen will come up asking if you are sure you want to delete the group.

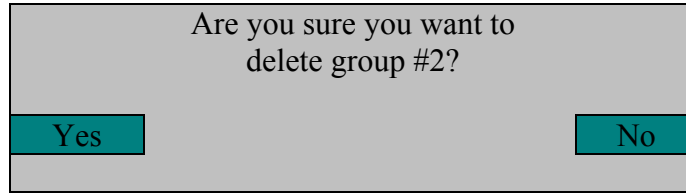

**Press the Edit Promotion icon** will bring up a screen listing the existing groups that can be edited.

Use an icon to choose a group to be edited and a screen will come up which will allow you to edit the group.

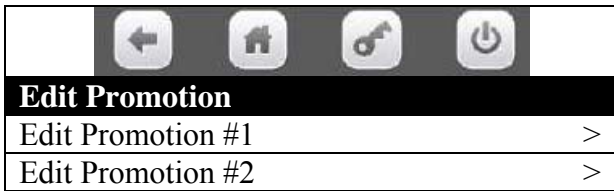

Use the Edit Promotion ## icon to save the changes made to the group after you have finished editing. **It is the save button for your group. If you fail to save the changes, the work you have done editing will be lost!**

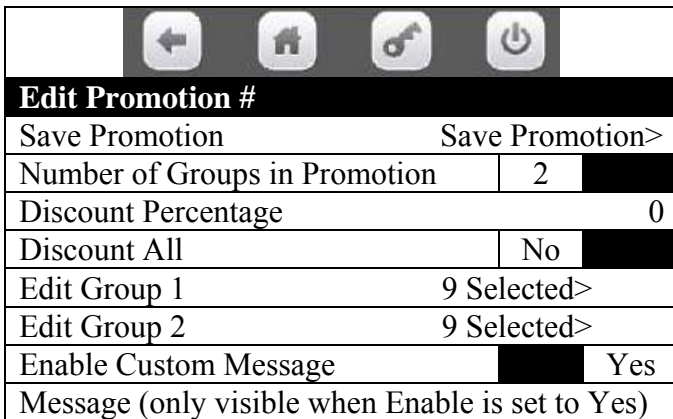

Use the numeric icons to select a promotion group to edit.

Once a group is selected a screen will come up that will allow you to select a tray, then a screen will come up that will allow you to edit all the selections on that tray.

Some selection lists use more than one screen. Use the top arrow and bottom arrow on the right side of the screen to scroll through the multiple screens if needed.

	
<b>Edit Selections</b>	
1) Set All	>
2) Clear All	>
<b>101</b>	
101	√
102	√
103	√
104	√
105	√
106	√
107	√
108	√
109	√

Press the Set All icon will include all selections on the tray in the group. A check will appear for each selection.

Press the Clear All icon will remove all selections on the tray from the group. All checks for selections will disappear.

Press an icon for an individual selection will include or remove that selection from the group. Checks will appear and disappear for the chosen selection.

The list uses more than one screen, use the top and bottom of the OK Key to scroll to the desired selection.

Checked selections are included in the Group.

**When you have finished Editing, you MUST return to the screen with “SAVE GROUP” icon and press it to save the changes you have made to the group. If you fail to save your changes, the changes will be lost!**

**Press the Combo Vend Selection Mapping** will bring up a screen showing Tray icons.

Press a Tray icon will bring up a screen that will let you see the Combo Vend Selections for that Tray.

	
<b>Combo Vend Selection Mapping</b>	
Tray #1	>
Tray #2	>
Tray #3	>
Tray #4	>
Tray #5	>

Choosing a tray will bring up a list of the selections on that tray.

The right side of the selection list will tell you what group each selection is assigned to, or that it is unassigned.

	
<b>Tray #2 Combo Selections</b>	
201	Promo #1
202	Promo #1
203	Promo #1
204	Promo #1
205	Promo #1
206	unassigned
207	unassigned
208	unassigned
209	unassigned

**4. Token Enable – Press the icon to bring up a screen.**

Press the icon will bring up a tray list.

Use an icon to choose a tray.

Choosing a tray will bring up a screen that will allow you to include or remove selections that will work with tokens and coupons.

<b>Token Enable</b>	
Tray #1	>
Tray #2	>
Tray #3	>
Tray #4	>
Tray #5	>

<b>Tray #2</b>	
Set All	>
Clear All	>
201	✓
202	
203	✓
204	
205	✓
206	

Press the Set All icon will include all selections on the tray to accept Token for a Vend. A check will appear for each selection. Press the Clear All icon will remove all selections on the tray to accept Token for a Vend. All checks for selections will disappear. Press an icon for an individual selection will include or remove that selection to accept Token for a Vend. Checks will appear and disappear for the chosen selection.

**IMPORTANT: Tokens must also be enabled in the Money Menu under Bill Acceptance in order to work. Also, your coin mechanism and/or bill validator must be tuned and/or configured to accept the token or coupon you are using.**

**5. Rapid Vend – Press the icon to bring up a screen.**

Press the icon will toggle the setting in the live window between No and Yes.

<b>Special Vend Modes</b>	
Free vend	Off
Winner Mode	>
Combo Vends	>
Token Enabled	>
Rapid Vend	No
MultiVend Discount	>

1. When set to No, the shopping cart is active and you can use it to purchase multiple items in one transaction. The Buy More icon is used to select another purchased item. The Purchase icon must be used to complete the transaction.
2. When set to Yes, the shopping cart is disabled and the transaction is completed when the selection is made and delivered. The Purchase icon is not used to complete the transaction.



1. Set to No.

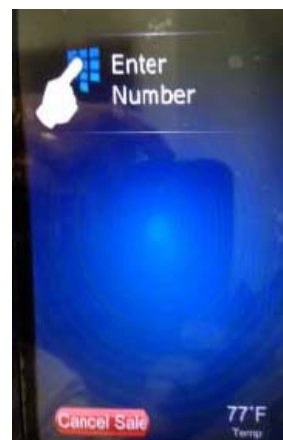

2. Set to Yes.

**6. MultiVend Discount – Press the icon to bring up a screen.**

Press the icon will toggle the setting in the live window between No and Yes.  
When set to No, the display will show the below message.

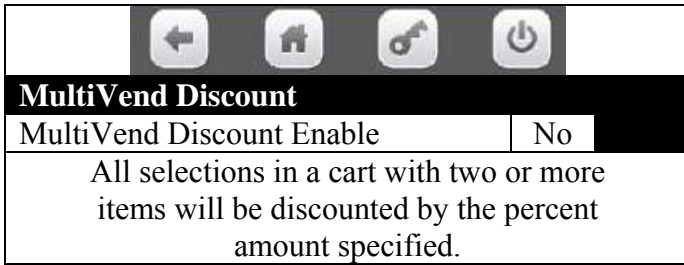

When set to Yes, the display will show the below message.

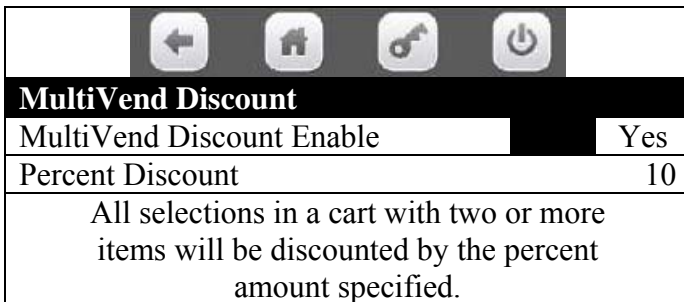

Press the Percent Discount icon to open a window to allow setting the percent number to discount. Use the ← arrow to delete last number entered. Press the “Done” icon to save the percent you wish to Discount MultiVends.

**7. MONETARY..... Press the icon to bring up a screen.**

Press the icon will bring up a screen listing all of the functions that can be accessed within this group.

Use the icons to choose a function.  
Choosing a function will bring up the first screen for that function or toggle choices.

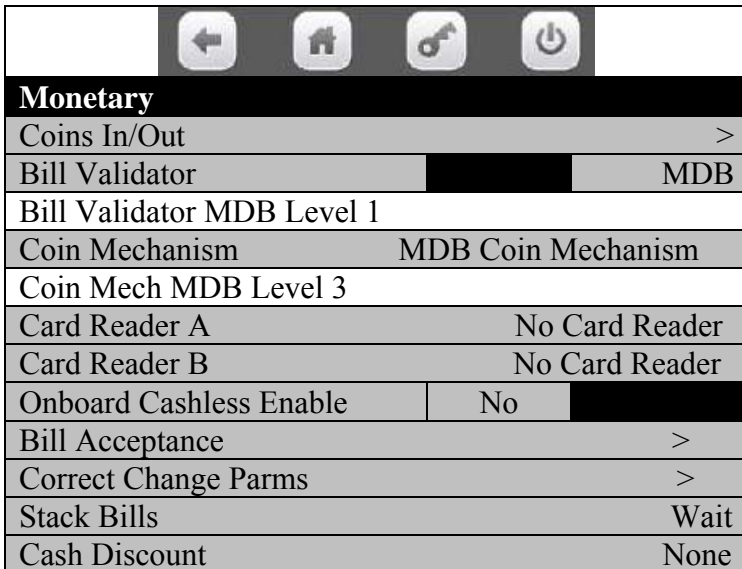

Bill Validator MDB Level 1.

Coin Mech MDB Level 3.

Some selection lists use more than one screen. Use the top arrow and bottom arrow on the right side of the screen to scroll through the multiple screens if needed.

Current settings are listed on the right side of the line.

**1. Coins In/Out – Press the icon to bring up a screen.**

Press the icon will bring up a screen divided into two sections.

<b>Coins In/Out</b>		
Stop dispensing		>
Coin	Count	Value
0.05	0	\$ 0.00
0.10	0	\$ 0.00
0.25	0	\$ 0.00
0.05	>	
0.10	>	
0.25	>	
Setup channels	>	

1. The top section is a table listing the type of coin, the number of coins, and the value of the coins.

2. The bottom section of the screen allows you to pay out selected coins using the icons. To stop pay out of coins press the Stop dispensing icon.

Press the icon to Setup channels.

Press the Setup channels icon will allow you to toggle the setting in the live window between On and Off.

The ON setting – Enables the Auto-detection feature for the machine.

The OFF setting – brings up a screen allowing you to use the numeric icons to check and un-check the channels.

<b>Channels Visibility</b>	
Auto detection	Off
Channel #1	√
Channel #2	√
Channel #3	√
Channel #4	√
Channel #5	√
Channel #6	
Channel #7	
Channel #8	
Channel #9	
Channel #10	
Channel #11	
Channel #12	
Channel #13	
Channel #14	
Channel #15	
Channel #16	

Use the icon to toggle the Auto-Detection feature between On and Off.

If set to Off use the icons to check and un-check the channels.

The checked channels are active.

The list uses more than one screen.

Some selection lists use more than one screen. Use the top arrow and bottom arrow on the right side of the screen to scroll through the multiple screens if needed.



**2. Bill Validator – Press the icon to toggle the setting between MDB and No Bill Validator.**

Press the icon will allow you to toggle the setting in the live window between MDB and No Bill Validator. The current setting is displayed at the right.

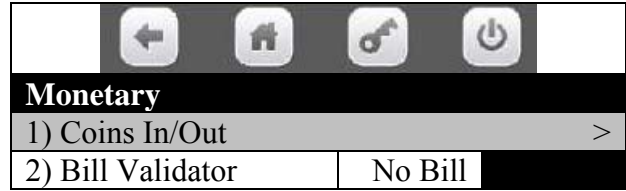

**3. Coin Mechanism – Press the icon to bring up a screen.**

Press the icon will bring up a screen allowing you to choose the type of coin mechanism being used.

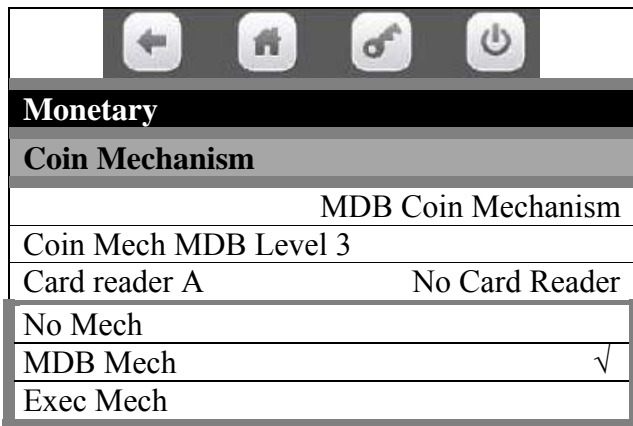

Use the icons to select the type of coin mechanism in the machine.

The checked option is active.

Use the “Done” icon to accept any changes.

**4. Card Reader A – Press the icon to bring up a screen.**

Press the icon will bring up a screen allowing you to choose the card reader type being used.

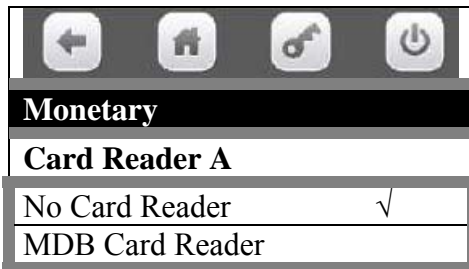

Use the icons to select the type of card reader being used in the machine.

The checked option is active.

Use the “Done” icon to accept any changes.

**5. Card Reader B – Press the icon to bring up a screen.**

Press the icon will bring up a screen allowing you to choose the card reader type being used.

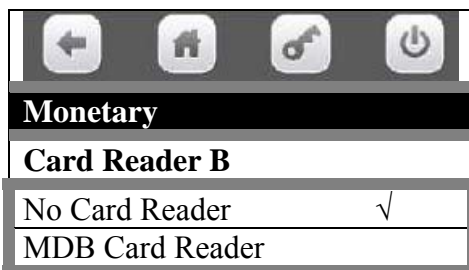

Use the icons to select the type of card reader being used in the machine.

The checked option is active.

Use the “Done” icon to accept any changes.

**6. Onboard Cashless Enable - Press the icon to bring up a screen.**

Press the icon to toggle the Onboard Cashless Enable feature between No and Yes.

<b>Monetary</b>	
Coins In/Out	>
Bill Validator	MDB
Bill Validator MDB Level 1	
Coin Mechanism	MDB Coin Mechanism
Coin Mech MDB Level 3	
Card Reader	No Card Reader
Onboard Cashless Enable	No
Bill Acceptance	>
Correct Change Parm	>

**7. Correct Change Parm – Press the icon to bring up a screen.**

Press the icon will bring up a screen listing all of the functions that can be accessed within this group.

<b>Correct Change Parm</b>	
Declining Balance	No
Force Vend	No
Accept On Low Change	\$0.00
Low Change Message	\$1.00
Credit For Failed Vend	Return Change
Allow Consumer Overpay	No

**Declining Balance** – Press the icon to toggle between Yes and No.

When the YES setting is selected, a declining balance will be allowed. This means that when money is inserted and a purchase is made, the change will be held for a period of time so that a second purchase can be made without re-inserting the money.

When the NO setting is selected, a declining balance will not be allowed. The change will be returned without delay at the end of a successful purchase.

- Force Vend** – Press the icon to toggle between Yes and No.  
 When the YES setting is selected, Forced Vend will be allowed. This means no change will be returned without a purchase.  
 When the No setting is selected, Forced vend is not allowed. This means change may be returned prior to purchase or selection.
- Accept On Low Change** – Press the icon to bring up a screen.  
 This will open a window allowing you to enter an amount using the numeric icons. This amount is the maximum amount of money that will be accepted by the machine when the coin mechanism is low on coins and may not be able to make change for a purchase.  
 The default setting is \$0.00 and setting an amount higher than that could cause the customer to be shortchanged.  
 Bill acceptance will not be allowed if there is less change than the value of the bill available to be returned.  
 Once the amount has been entered, use the “Done” icon to accept the new amount.

4. **Low Change Message** – Press the icon to bring up a screen.  
 This will open a window allowing you to enter an amount using the numeric icons.  
 This amount is the amount of change, that when reached, will cause a low change message to be displayed on the screen.  
 Once the amount has been entered, use the “Done” icon to accept the new amount.
5. **Credit for Failed Vend** – Press the icon to bring up a screen.  
 Press the icon will bring up a screen that allows you to set an option in the case of a failed vend.

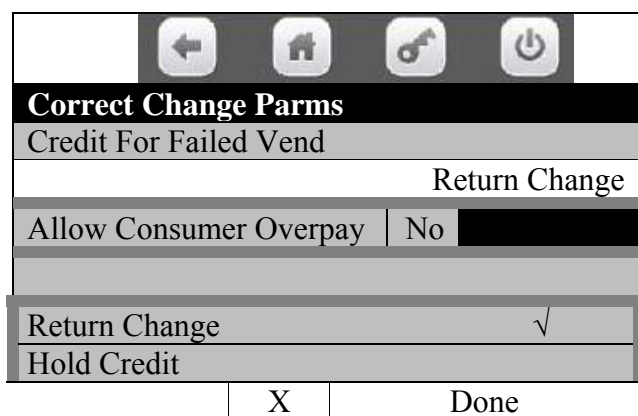

Use the icons to check and un-check the action that will happen in the case of a failed vend.  
**Return Change** - Return the credit to the customer.  
**Hold Credit** - Hold the credit to allow another vend attempt.

Press the “Done” icon to accept the new setting.

6. **Allow Consumer Overpay** – Press the icon to toggle between Yes and No.  
 This will change the setting in the live window between Yes and No. This allows you to set an option in the case there is not enough change to pay back, but will allow overpay and a vend.  
 When the YES setting is selected, Consumer Overpay will be allowed. This means the vender is allowed to vend with the risk of not being able to return the full amount of change.  
 When the No setting is selected, Consumer Overpay is not allowed. This means the vender is not allowed to vend unless it is able to return the full amount of change.

**8. Stack Bills – Press the icon to bring up a screen.**

Press the icon will bring up a screen listing all of the functions that can be accessed within this group.

Use the icons to check and un-check the action that will happen when a bill is inserted in the validator.

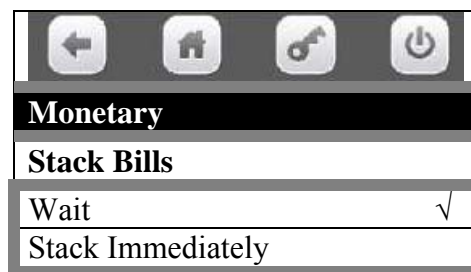

**8. Cash Discount – Press the icon to bring up a screen.**

Press the icon will bring up a screen listing all of the functions that can be accessed within this group.  
 Currently this item is not used.

## 8. SYSTEM SETTINGS.....Press the icon to bring up a screen.

Press the icon will bring up a screen that will allow you access to the functions in this group.

Use the icons to choose a function.

Choosing a function will bring up the first screen for that function or toggle choices.

Some selection lists use more than one screen. Use the top arrow and bottom arrow on the right side of the screen to scroll through the multiple screens if needed.

	
<b>System Settings</b>	
Machine Information	>
Time And Date	>
Language	>
DTS (data transfer system)	>
Software Updates	>
Backup / Restore	>
Clone (copy) Configurations	>
Clone Board	>
Screen Brightness	>
LED Color	Blue
Idle Time Out	30s
Advertisements	>
Custom Messages	>
Automatic Reboot Settings	>
Skip Main Menu	No

Current settings are listed on the right side of the line.

### 1. Machine Information – Press the icon to bring up a screen.

Press the icon will bring up a screen allowing you to select to set the Machine ID or set the Machine Location.

	
<b>Machine Information</b>	
<b>Machine ID</b>	BevMaxG
<b>Machine Location</b>	Location Not Set

Press the icon for “**Machine ID**” will open a live window allowing you to enter a Machine ID using an alpha numeric icon keypad. Use the numeric icons to choose a number to be entered in place of BevMaxG. Once the number has been entered, use the “Done” icon to accept the entry.

Press the icon for “**Machine Location**” will open a live window allowing you to enter a Machine Location using an alpha numeric icon keypad. Use the alpha numeric icons to enter the vender location. Once the information has been entered, use the “Done” icon to accept the entry.

**2. Time and Date – Press the icon to bring up a screen.**

Press the icon will bring up a screen allowing you access to the various settings in the function.

<b>Time and Date</b>	
<b>Time Zones</b>	Eastern
<b>Time Format</b>	use 24h
<b>Date Format</b>	North American (MM/DD/YYYY)
Machine will be rebooted after next door closure if time or date gets changed	
<b>Time</b>	09:33
<b>Date</b>	02/19/2013

Use the icons to choose a setting to be changed.

Choosing a setting will bring up a screen allowing the setting to be altered.

If the time or date is changed, the machine will re-boot on the next door closure.

<b>Time and Date</b>	
<b>Time Zones</b>	Eastern
<b>Time Format</b>	use 24h
<b>Date Format</b>	North American (MM/DD/YYYY)
Machine will be rebooted after next door closure if time or date gets changed	
Alaska	
Aleutian	
Arizona	
Central	
Dublin	
East Indiana	
Eastern	✓
Hawaii	
Indiana – Starke	
London	
Michigan	
Mountain	
Pacific	
Pacific-New	
Samoa	

**Time Zones** - Press the icon will open a live window allowing you to enter select the Time Zone by location.

Some selection lists use more than one screen. Use the top arrow and bottom arrow on the right side of the screen to scroll through the multiple screens if needed.

Use the icon to choose the Time Zone to be set.

Use the “Done” icon to accept the chosen selection.

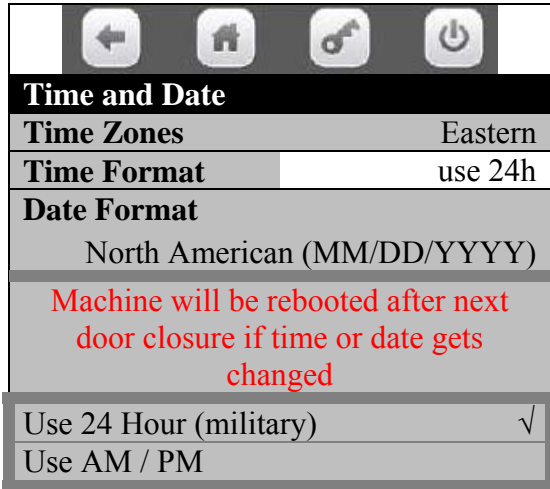

**Time and date** - Press the icon will open a live window allowing you to select the Time Format for displaying the time.

Use the icons to choose a format. The selected format will be checked.

Use the “Done” icon to accept the chosen selection.

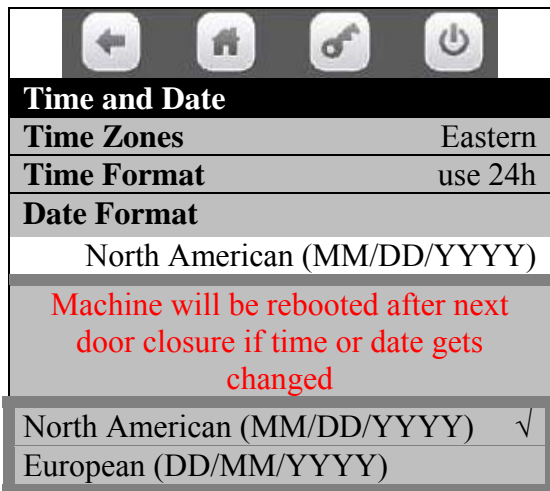

**Date Format** - Press the icon will open a live window allowing you to enter select the Date Format.

Use the icons to choose a format. The selected format will be checked.

Use the “Done” icon to accept the chosen selection.



**Time** - Press the icon will open a live window allowing you to set the Time.

Use the numeric icons to set the Time.

Use the “Done” icon to accept the chosen selection.

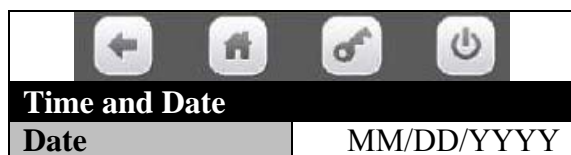

**Date** - Press the icon will open a live window allowing you to set the Date.

Use the numeric icons to set the Date.

Use the “Done” icon to accept the chosen selection.

**Language – Press the icon to bring up a screen.**

Press the icon will bring up a screen with language options.

<b>Language</b>	
<b>Service Application</b>	English-US
<b>User Interface</b>	>

Use the icons to choose a function.

Choosing a function will bring up the first screen for that function or toggle choices.

**Service Application** - Press the icon for Service Applications will bring up a screen that displays available languages for the service menus.

<b>Language</b>	
<b>Service Application</b>	English-US
<b>User Interface</b>	
Nederlands	
English-UK	
English-US ✓	

Use the icons to choose an option. The chosen option will be checked. Use the “Done” icon to accept the chosen selection.

**User Interface** - Press the icon for User Interface brings up a screen listing the choices for applying languages that will display to the customers.

<b>Language</b>	
Enable Languages	>
Default Language	English-US

Press the icon will bring up a screen listing two options.

Use the icons to choose a function. Choosing a function will bring up the first screen for that function.

<b>Enable Languages</b>	
English	
English-US ✓	
Nederlands	

**Enable Languages** - Press the icon will bring up a screen allowing you to select the language that is to be enabled in User Interface applications.

Use the icons to choose an option. The chosen option will be checked. Use the “Done” icon to accept the chosen selection.

<b>Default Languages</b>	
Enable Languages	>
Default Language	
English-US	
English-US ✓	

**Default Language** – Press the icon will open a screen showing the selected default language as checked and listed in the open window. This is the language that will be used in User Interface applications. Use the “Done” icon to accept the chosen selection.

**DTS (data transfer system) – Press the icon to bring up a screen.**

Press the icon will bring up a screen listing the functions in this group.

<b>DTS</b>	
DTS Standby mode	DEX
DTS Audit List	>
CA304 / CA308 Data Type	Numeric
Data Reset after Transfer	Reset
Event Data Reset after Transfer	Reset
Passcode Reset	>
DTS Cache Settings	>

Use the icons to choose a function. Choosing a function will bring up the first screen for that function, or toggle settings.

**DTS Standby mode** - Press the icon will bring up a screen allowing you to choose the way the Data is transferred.

<b>DTS</b>	
DTS Standby mode	DEX
<b>DTS Audit List</b>	
CA304/CA308 Data Type	Numeric
Onboard Cashless Data	DA
<b>Data Reset on Transfer</b>	
DDCMP	
DEX	√

Use the icons to choose a function. The selected option will be checked. Use the “Done” icon to accept the chosen selection.

**\*Domestically the setting will typically be set for DEX.**

**DTS Audit List** - Press the icon will bring up a screen divided into two sections.

Use the icons to select an action. Selecting an action will cause all the items in the audit list to change status to active or in-active depending on the icon used.

<b>DTS Audit List</b>	
Set All	>
Clear All	>
<b>DTS Audit List</b>	
ID 1	√
ID 4	√
ID 5	√
VA 1	√
VA 2	√
VA3	√
BA 1	√

Use the icons to change the status of individual lines.

Checked lines are active. This gives you the ability to shorten the DEX file. Do not remove items without checking with your DEX provider or manufacturer representative. Some selection lists use more than one screen. Use the top arrow and bottom arrow on the right side of the screen to scroll through the multiple screens if needed.

Audit list that is available is as follows:

ID 1, ID 4, ID 5. VA 1, VA 2, VA 3. BA 1. CA 1, CA 2, CA 3, CA 4, CA 7, CA 8, CA 9, CA 10, CA 15, CA 17, CA 22. CB 1. DA 1, DA 2, DA 3, DA 4, DA 5, DA 6, DA 10. DB1, DB2, DB3, DB4, DB5, DB6, DB10. TA 1, TA 2. PA 1, PA 2, PA 3, PA 4, PA 5, PA 7, PA 8. EA 1, EA 2, EA 3, EA 4, EA 5, EA 6. MA 5. LA 1.



**CA304.CA308 Data Type** - Press the icon will bring up a screen allowing you to choose the way to display Bill Data in these files.

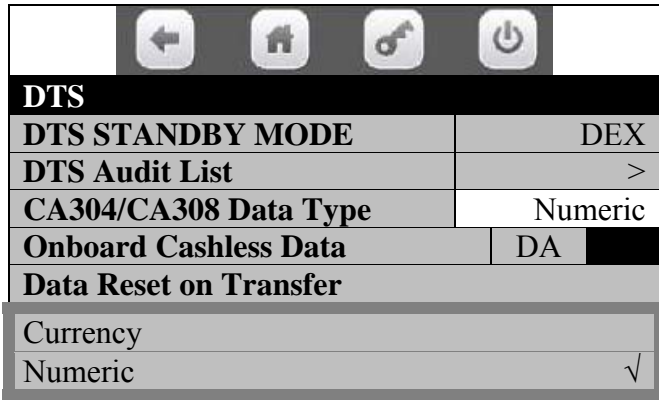

Use the icons to select an option. The Currency setting will display bills as a monetary value. The Numeric setting will display bills as the number of bills.

Once the option is selected, use the “Done” icon to accept the changes.

**Onboard Cashless Data** – Press the icon will transfer the setting in a live window from DA to DB.

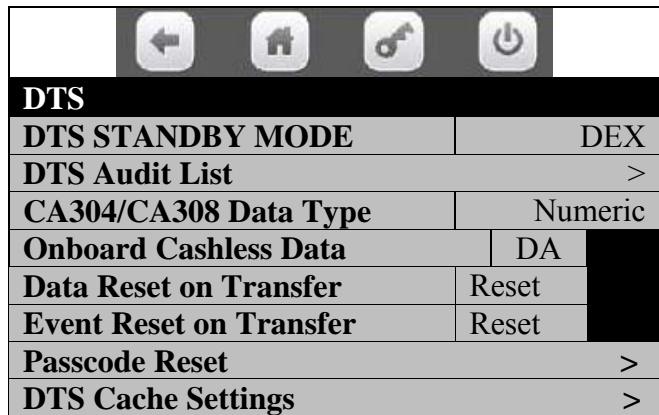

DA/DB Setting. DA refers to the first cashless module in the machine and DB refers to the second cashless module in the machine (if installed).

**Data Reset on Transfer** - Press the icon will transfer setting in a live window between RESET and NO. If the RESET setting is active, all the resettable data will be reset to zero upon successful completion of a data transfer. If the NO setting is active, the resettable data will not be reset.

**Event Reset on Transfer** - Press the icon will transfer setting in a live window between RESET and NO.

If the RESET setting is active, all the event data will be reset upon successful completion of a data transfer. If the NO setting is active, the event data will not be reset.

**Passcode Reset** - Press the icon for Passcode Reset will bring up a screen asking if you are sure you want to reset the passcode. This function does not work and will be removed in all future software revisions.

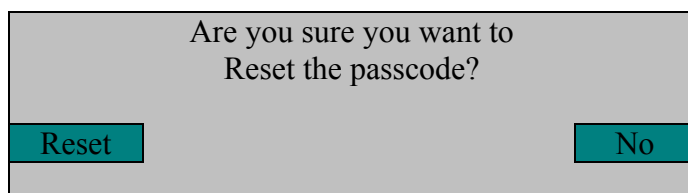

Press the Yes icon to choose to reset the passcode. **Note: This feature does not work at this time.** Press the No icon to choose not to reset the passcode.

**DTS Cache Settings** - Press the icon will bring up a screen for DTS Cache Settings.

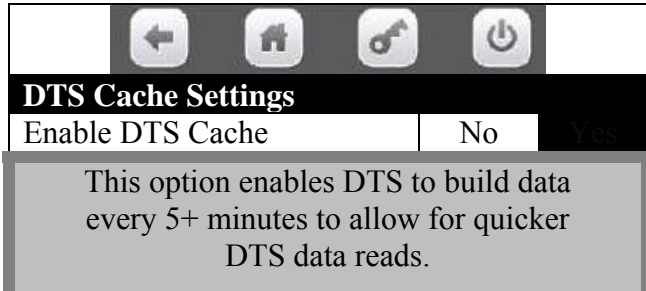

Press the icon to toggle between No and Yes. When set to No, DTS Cache is disabled or off.

When set to Yes, DTS Cache is enabled or turned on.

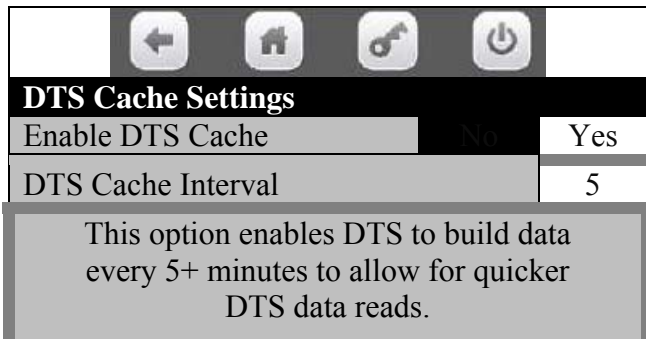

Press the DTS Cache Interval icon to open the window to allow you to change the time. Press the numeric icons for the time interval you wish to use. Use the “Done” icon to accept the time selected.

**Software Updates – Press the icon to bring up a screen.**

Press the icon will bring up a screen with only one option.

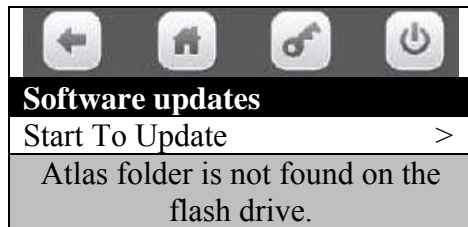

Press the Start to update icon will choose the option. Choosing the option will bring up a screen prompting further action. If you have no memory stick installed in USB Port 3 – A screen will come up stating that the Atlas folder is not found, Re-Plug the Stick and Re-Boot the Machine.

If a memory stick is installed in USB port 3 – A screen will come up listing the files available on that stick that can be used for an Up-Grade.

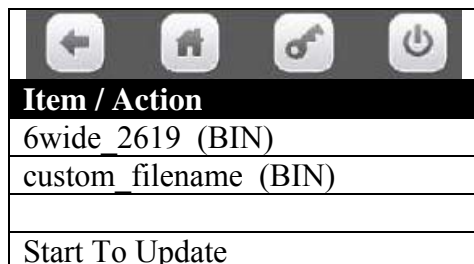

Use an icon to choose the file to be used for the Up-Date. Use a numeric Key to Start to Up-Date. This may take several minutes. When done, shut down the machine and re-start.

**Note: It is recommended that a backup copy always be made before Up-Dating software.**

**Backup / Restore – Press the icon to bring up a screen.**

Press the icon will bring up a screen listing the available options for this function.  
This function is used to create, save, and re-store configuration settings within a machine.



Use the icons to choose an option.

Choosing an option will bring up a screen asking if you are sure you want to complete the action.

Press the Make new Backup icon to make a new backup file.

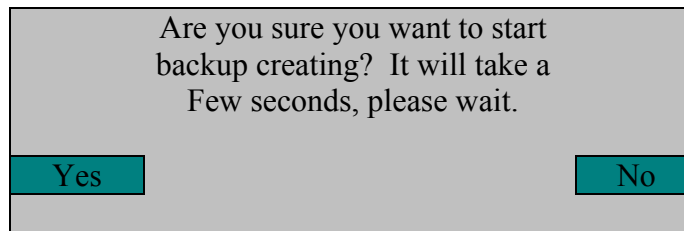

Press the YES icon, or the NO icon.

1. Use the Yes icon to make a new backup. They are listed by number. The new backup will be a copy of the currently set prices, product codes, motor pairings and any other options you have set up in the currently loaded firmware.
2. Use a numeric icon to choose the stored backup copy you wish to restore to.
3. Use a numeric icon to restore the factory backup

Press the Restore Factory Backup icon to restore factory backup.

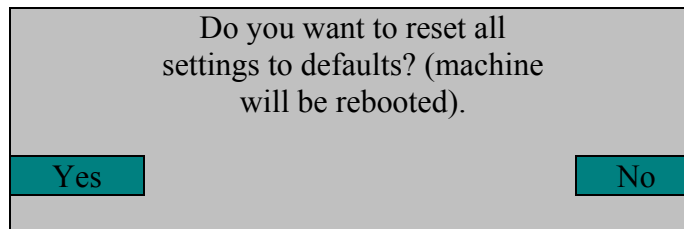

1. When the Yes icon has been pressed, the restore will begin. After it has been restored the lights will come back on and you are ready to test the machine to be sure it is set the way you want it. You do not have to reboot the machine.
2. When the No icon has been pressed, nothing will be changed or restored.

**Clone (copy) Configurations – Press the icon to bring up a screen.**

Press the icon will bring up a screen listing the available options for this function.

This function is used to load a memory stick that can be used to copy the current configuration settings from a machine to other machines, making them all identical.

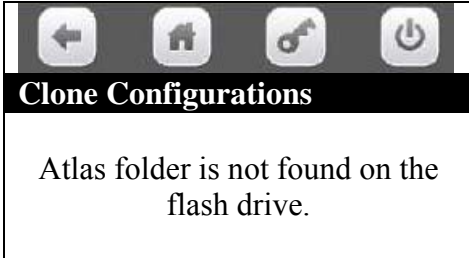

If there is no USB flash drive plugged in USB Port 1 on the Control Board, a screen will come up saying, flash stick not found, please replug it and reboot machine.

**1. Prepare Flash Drive -**

Before attempting to copy a configuration you must create a folder named atlas on a USB flash drive using a computer. The USB flash drive will then need to be inserted in to any available USB port 1 on the Control Board. Note: USB 1 is where the radio is connected if using on board telemetry. Do not unplug the radio.

After preparing the flash stick and inserting it in to an available USB Port.

**2. Create Configuration Clone -**

Function
Create Configuration Clone

Press the icon will bring up a screen that allows you to load the memory stick. There are two options:

Function
Name Clone
Make Clone

Press the Name Clone icon will open a window that will allow you to give the clone a name using the icons. The stick can contain more than one clone.

Press the Make Clone icon will save the clone to the memory stick using the name you have given it.

Function
Create Configuration Clone
Your name from 100003557
Another clone

Once the clone has been saved to the stick, the first screen will be expanded to include all the clones that are saved to the stick. Press the icon to choose a clone will bring up a screen with two options.

**3. Install/Remove Configuration Clone –**

Function
Install
Remove Clone From Stick

Press the Install icon will bring up a screen asking if you are sure you want to install the clone.

Press the Remove Clone from Stick icon will bring up a screen asking if you are sure you want to remove the clone from the stick.

In both cases, respond by pressing the icon.

- A. Press the YES icon – and the action will be carried out.
- B. Press the NO icon – and the action will not be carried out. The screen will return to the previous choices.

**Clone (copy) Board– Press the icon to bring up a screen.**

Press the icon will bring up a screen listing the available options for this function.  
This function is used to load a memory stick that can be used to copy the current board information from this vender.

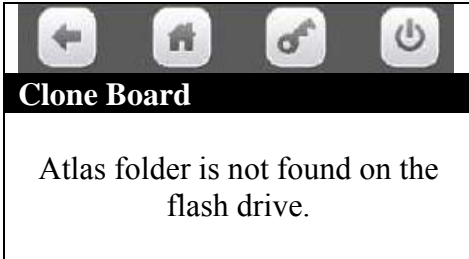

**Screen Brightness – Press the icon to bring up a screen.**

Press the icon will bring up a screen that has two options.



Press the Screen brightness icon will open a window that allows you to enter a new setting for the screen brightness. 79 is the default value.

Use the icons to enter a new value from 10 to 90. Use the Done icon to accept the new setting selected and change the screen brightness.

Press the Save Current Brightness to save the new value and return you to the Systems Settings Menu.

**LED Color – Press the icon to bring up a screen.**

Press the icon will bring up a screen listing the available options for setting the LED color.



Press the color icon to check the desired color. The checked color will be the color used.

Press the Done icon to lock in your choice and the color of the LED's will change and you will be returned to the menu.

**Idle Time Out – Press the icon to bring up a screen.**

Press the icon will open a window allowing you to enter a new time to set the time in seconds for idle time out to return to operation using the touch pad.

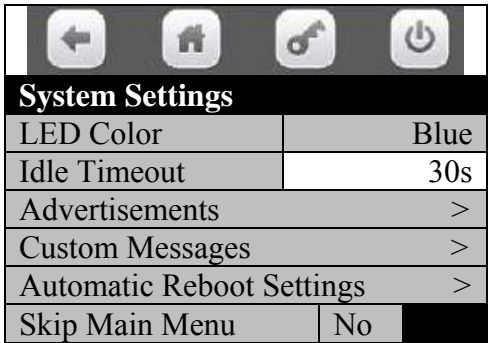

<b>System Settings</b>	
LED Color	Blue
Idle Timeout	30s
Advertisements	>
Custom Messages	>
Automatic Reboot Settings	>
Skip Main Menu	No

Use the numeric icons to enter a new value from 15 seconds to 100 seconds. Use the center of the Done icon to lock in the new time.

30 seconds is the default time.

**Advertisements – Press the icon to bring up a screen.**

Press the icon will bring up a screen listing five options.

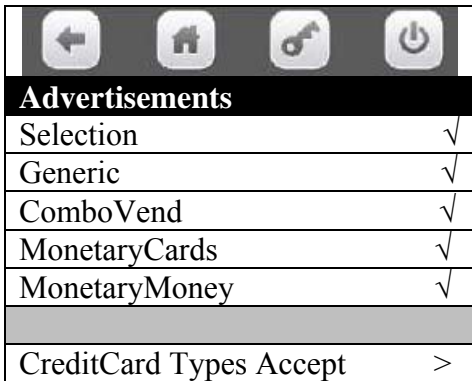

<b>Advertisements</b>	
Selection	√
Generic	√
ComboVend	√
MonetaryCards	√
MonetaryMoney	√
CreditCard Types Accept	>

Use the icons to check or uncheck the options.

The checked options are active.

The default setting is for all five to be checked or active.

This menu will show all advertisements that are currently loaded on the machine. It is not necessarily just the five listed, since the customer may have uploaded an advertisement configuration.

If CreditCard Types Accept is selected, a list of card types will be displayed. Use the icons to check or uncheck the options.



<b>CreditCard Types Accept</b>	
Visa	√
Master Card	√
American Express	√
Discover	√
ID Card	

**Custom Messages – Press the icon to bring up a screen.**

Press the icon will bring up a screen listing the options for messages.

	
<b>Custom Messages</b>	
Use Vending Screen Message	√
Vending Screen Message ( Message not Set)	
Use Idle Screen Message	√
Idle Screen Message ( Message not Set)	

Press the Use Vending Screen Message or Use Idle Screen Message icons to check or uncheck the option to use the message. Note: Vending Screen Message and Idle Screen Message options only appear if Options at Use Vending Screen Message or Use Idle Screen Message are checked.

Press the Vending Screen Message and Idle Screen Message icons to open a window allowing you to create your own message. Use the alpha numeric icons to enter the message. Once the information has been entered, use the “Done” icon

to accept the entry.

**Automatic Reboot Settings – Press the icon to bring up a screen.**

Press the icon will bring up a screen listing the options for

<b>Automatic Reboot Settings</b>	
Machine will be rebooted after next door closure if reboot settings are changed	
Enable Automatic Reboot	Yes
Reboot Time	02:00
Idle Time Seconds	300
<b>Automatic Reboot Settings</b>	
Reboot Time	HH:MM
Idle Time Seconds	300

Press the icon will toggle the Enable Automatic Reboot between Yes and No. Yes will enable the Automatic Reboot to occur at the time set. No will not allow an Automatic Reboot.

Press the Reboot Time icon will open a window allowing you to enter a time in HH:MM using the numeric icons to allow the Automatic Reboot to automatically occur. Use the Done icon to lock in the

new time.

<b>Automatic Reboot Settings</b>	
Idle Time Seconds	300

Press the Idle Time Seconds icon will open a window allowing you to enter a time in seconds using the numeric icons to allow for idle time out to return to

operation. Use the Done icon to lock in the new time.

**Skip Main Menu – Press the icon to bring up a screen.**

Press the icon will toggle the setting from No to Yes.

	
<b>System Settings</b>	
LED Color	Blue
Idle Timeout	30s
Advertisements	>
Custom Messages	>
Automatic Reboot Settings	>
Skip Main Menu	No

When set to yes, the Main Menu will be skipped.

When set to no, the Main Menu will display.

**9. SECURITY CODES.....Press the icon to bring up a screen.**

Press the icon will bring up a screen listing the following options.



Use the icons to choose an action.

Choosing an action will bring up a screen or open a window that will allow you to complete the action.

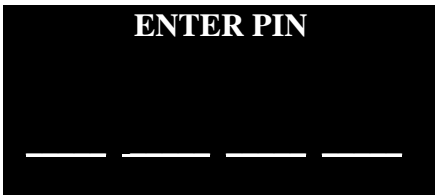

**Press the Enter PIN** icon will bring up a screen asking you to enter the PIN. The default number is 3,3,3,3 for the Operator PIN or Personal Identification Number. Entering this number will bring up the service mode menu. There are different PIN's that may be entered here to enable different menu sets. They include operator, Driver, Manufacturing, and Engineering PINs.

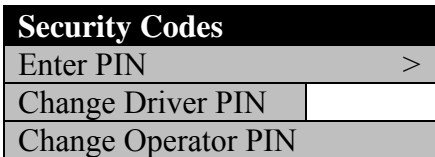

**Press the Change Driver PIN** icon will open a window that will allow you to change the Driver PIN. The default number is 1,1,1,1. Use the numeric icons to enter a new 4 digit number. Use the Done icon to lock in the new PIN number.

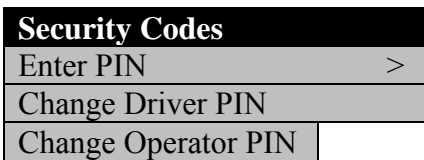

**Press the Change Operator PIN** icon will open a window that will allow you to change the Operator PIN. Use the numeric icons to enter a new 4 digit number. Use the Done icon to lock in the new PIN number.

**Entering the Operator PIN of 3,3,3,3** will allow full access to all the Operators functions in the service mode as detailed in the pages of the programming section of the manual.

**Entering the Driver PIN of 1,1,1,1** will allow a driver limited access to the service mode functions listed as follows:

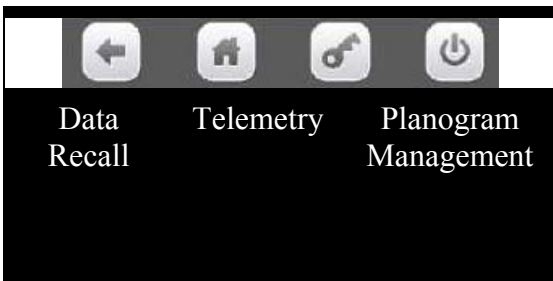

Use the icons to choose an option. Choosing an option will bring up the first screen for that option.



Press the Data Recall icon will bring up a screen listing two options for Data Recall.

<b>Data Recall</b>	
Non Resettable Sales Data	Refer to Section 1 Data Recall
Resettable Sales Data	Refer to Section 1 Data Recall

Use the icons to choose an option. Choosing an option will bring up a screen listing data categories as described in the Data Recall section of this manual.

Press the Telemetry icon will bring up a screen stating that this unit is currently unassigned – please log in with a higher level PIN entry to assign this unit.

<b>Telemetry</b>	
This unit is currently unassigned. Please log in with a higher level PIN entry to assign this unit.	

Press the Planogram Management icon will bring up a screen with two options.

<b>Planogram Management</b>	
Planogram Audit	>
Edit Planogram	>

Use the icons to choose an option. Choosing an option will bring up the first screen for that option.

Press the Planogram Audit icon will bring up a screen with three actions.

<b>Planogram Audit</b>	
Selection Code	
Undefined	
Product	101
Picture	\$0.05
Previous	Next

Use the icons to choose an action. Press the Selection Code icon opens a window to enter a selection number to view data. Press the Previous icon moves back to the previous selection number to view its data. Press the Next icon moves forward to the next selection number to view its data. Use the Done icon to lock in the new number. Press the **X** Key moves back to the Planogram Management Menu.

When a selection number is entered or scrolled to, a screen will come up listing the following data about that selection.

- A. The name of the product, if defined.
- B. The Universal Product Code.
- C. The currently set price for the product.

Press the Edit Planogram icon will bring up a screen with four actions.

←		🏠		🔑		🔌	
<b>Edit Planogram</b>							
Selection Code				101			
<b>Undefined</b>							
Product				101			
Picture				\$0.05			
UPC				101			
Previous				Next			

Press the Selection Code icon opens a window to enter a selection number to view data.  
 Press the UPC icon opens a window to enter a UPC number to view data.  
 Press the Previous icon moves back to the previous selection number to view its data.  
 Press the Next icon moves forward to the next selection number to view its data.  
 Use the Done icon to lock in the new number. Press the **X** Key moves back to the Planogram Management Menu.

**Entering the Engineering PIN of 4,4,4,4** will bring up a screen very similar to the Operator service screen. **IMPORTANT:** This is for Factory Engineering use only and should not be used in the field.

Added options include:

In the **TEST** mode functions, Reliability Test icon and Reliability Keypad Test icons are added tests, shifting the other entries down. These tests are meant for Factory Engineering use only and should not be used in the field.

<b>Test</b>	
Test Vend	>
Coin Return Motor	>
Reliability Test	>
Surround Lighting Test	>
Screen Test	>
Refrigeration System	>
MagTeck Head Test	>
Cashless system test	>
Monetary	>
Port and Cup Sensors	>
Platform Movement	>
Turn Lighting Off	>

Press the icons to choose a function.

Choosing a function will bring up the first screen within each function.

In the **Special Vend Modes** functions, a function called “Trade Show Vend Bypass” was added shifting other entries down.

←		🏠		🔑		🔌	
<b>Special Vend Modes</b>							
Free vend				Off			
Winner Mode				>			
Combo Vends				>			
Token Enabled				>			
Trade Show Vend ByPass		No					
Rapid Vend		No					
MultiVend Discount				>			

Use the icons to choose a function.

Use the Trade Show Vend ByPass icon to toggle between No and Yes for the Trade Show Vend ByPass function.

In the **Security Codes** Mode functions, Change Engineer PIN function was added.

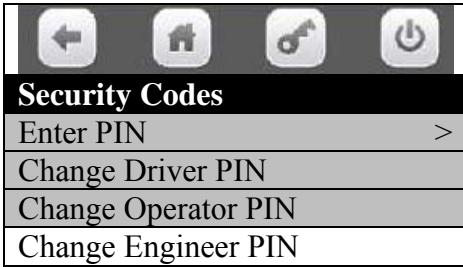

Press the Change Engineer PIN icon will open a window that will allow you to change the Engineer PIN. Use the numeric icons to enter a new 4 digit number. Use the Done icon to lock in the new number.

This feature is meant for Factory Engineering use only and should not be used in the field.

**Entering the Manufacturing PIN of 5,5,5,5** will bring up a screen used in the factory for set up and testing. **IMPORTANT:** This feature is meant for Factory use only and should not be used in the field.

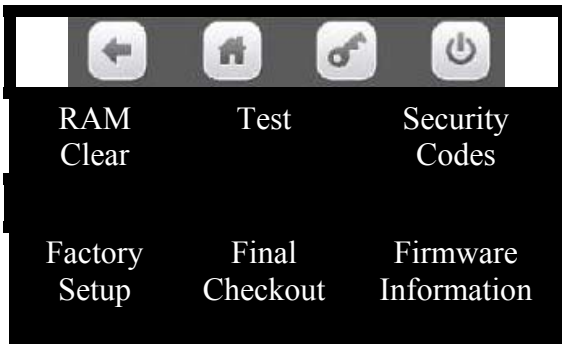

Use the icons to choose an option.

Choosing an option will bring up the first screen for that option.

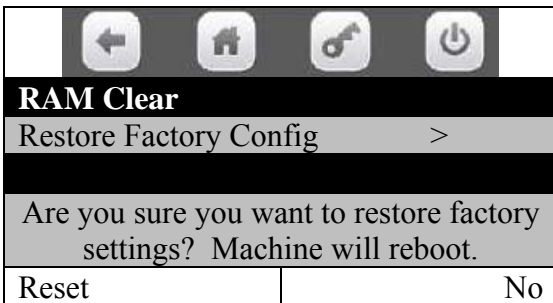

Press the RAM Clear icon will bring up a screen with the option to restore factory config and clear all Databases. Press the Reset icon to restore factory settings. Press the No icon to return to the Menu Screen.

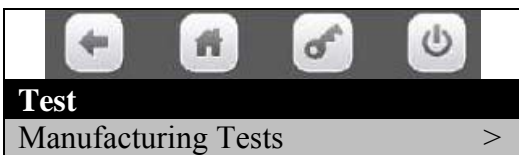

Press the Test icon will bring up a screen with the option for Manufacturing Tests. In version 10.8.2 this has been removed. In software versions prior to 10.8.2 this menu was visible but did not work. Press the back icon to return to the Menu Screen.

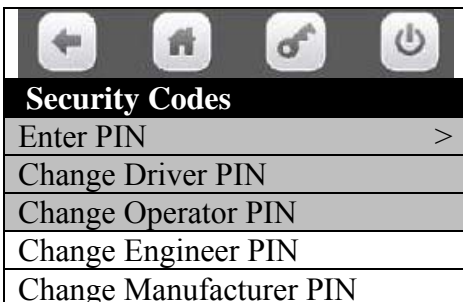

Press the Security Codes icon will bring up a screen with five options. #Change Engineer PIN and Change Manufacturer PIN are added options. Press the back arrow to return to the Menu Screen.

Change the PIN numbers in the same manner as listed in the Operators Menu Security Codes of the manual.

Press the Factory Setup icon will bring up a screen listing the options and functions for Factory Setup and Screen Brightness.

Factory setup	
Next Step	>
Diagnostics	>
Screen Brightness	
Screen Brightness	

Use the icons to choose an option.  
 Choosing an option will bring up the first screen for that option.  
 Press the Next Step icon will scroll forward through the available options of settings to adjust.  
 Press the Diagnostics icon will list any errors registered.  
 Press the Screen Brightness icon will enter the option shown and allow adjustments as explained in System Settings Screen Brightness section of this manual. Press the Done icon to save new setting. Press the **X** icon to move backward 1 step in the menu.

Press the Next Step icon will scroll forward through the available options of settings to adjust.  
 Press the Diagnostics icon will list any errors registered. Press the EVS Compliant icon will toggle the option setting shown from No to Yes. Press the back arrow icon to move backward 1 step in the menu.

Factory setup	
Next Step	>
Diagnostics	>
EVS Compliance	
EVS Compliant	No

Press the Next Step icon will scroll to the next item available and bring up a screen with the option.  
 Press the Diagnostics icon will list any errors registered.

Factory Setup	
Next Step	>
Diagnostics	>
Machine Configuration	
Shelf Location	D2
Model Number	3800
Shelf Offset	700

Press the Shelf Location icon will enter the option shown and allow you to select the available Shelf Location Settings. Use the icons to check or uncheck the options. The checked option is active.

Factory Setup	
Shelf Location	
D	
D2	✓
E1	
E2	
E3	
E4	
E5	
E6	
G	
M1	
M2	

Press the Done icon to save selection and return to the Factory Setup menu. Press the **X** icon to move backward 1 step in the menu.

Press the Model Number icon to toggle the model number from 3800 to 5800.



Press the Shelf Offset icon to enter the Shelf Offset option and open a window that will allow you to change the setting. The factory default setting is 700.

Adjust Shelf (Y) Offset (up and down). To change the offset enter a new number (3310 counts = 1 inch) and press the Done

icon to save and display will show Shelf Offset ###. Press the **X** icon to move backward 1 step in the menu.

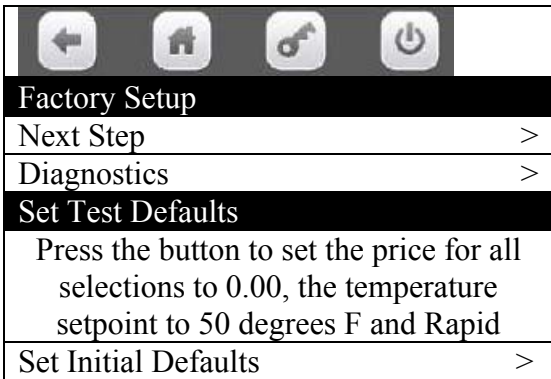

Press the Next Step icon will scroll to the next item available and bring up a screen with the option. Press the Diagnostics icon will list any errors registered.

Press the Set Initial Defaults will make the changes listed on display and the display will move to the Next step.

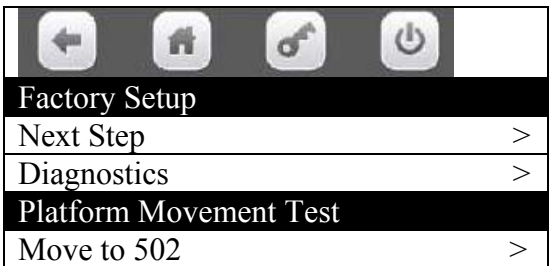

Press the Move to 502 icon and the platform moves to the 502 position. The icon text changes to Cycle Cup Plunger, which causes the plunger to cycle when pressed. The icon text then changes to Move to 508 and repeats process for 108 and 102. Then the test is complete with an icon message stating the platform will be homed when the Next icon is pressed. Note: Make sure the left door switch is activated (pulled to the out position) so that the motors are powered. If

this switch is not pulled out, then the motors won't move and nothing will happen.

Press the Next Step icon will scroll forward through the available options of settings to adjust. Press the Diagnostics icon will list any errors registered. Press the Move to Swipe Position icon will move the

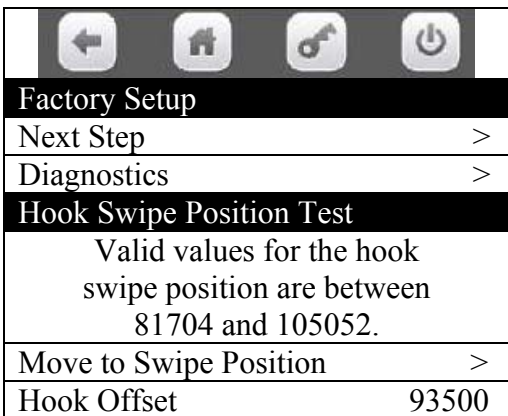

Delivery (Picker) Cup to the delivery position at the Port opening. Make sure the door switch is activated so that the motors are powered. If this switch is not pulled out, then the motors won't move and nothing will happen.

Press the Hook Offset icon to enter the Hook Offset option and open a window that will allow you to change the setting. The factory default setting is 93500.

Adjust hook Offset (right and left). To change the offset enter a new number (3310 counts = 1 inch) and press the Done icon to save, the display will show Hook Offset #####, the cup will move back to the home position. Press Move to Swipe Position

icon to test new setting. Press the Next step icon to scroll to the Next step. Press the back arrow icon to move backward 1 step in the menu.



Press the Next Step icon and display will show Initial Setup is complete.

Press Return to Main Menu icon to return to the Factory Main Menu.

**Or Close door to exit program.**

**TIMED EVENTS..... Press the icon to bring up a screen.**

Press the Timed Events icon, bottom left on the touch pad, will bring up a screen listing the timed events options.



Use the icons to choose an option.

Choosing an option will bring up the first screen for that option.

**1. Press the Time of Day Events icon will bring up the first screen for this menu.**



Use the icons to choose the type of event you wish to create. Choosing a type of event will bring up the first screen for that type of event.

1. Press the Price Adjust icon will bring up a screen listing options for Price Adjust.



Press the Create Event icon here will create an event and begin a list of saved events that can be set up as needed. If no events have been created you will see a message – There is no Price Adjust event on this machine. You can create one if it's needed.

Use the icons to choose a created event to set up for use and another screen will come up allowing you to configure the event to fit your needs.

Press the Save this event icon to **SAVE your settings or your work will be lost.**

Press the Remove this event icon to REMOVE the event from memory.

Press the Enable state icon to toggle the setting for the state of the event between ON and OFF.

Press the Frequency icon to toggle the setting for the frequency of the event between DAILY and WEEKLY.

Press the Start Time icon to open a window allowing you to use the numeric icons to enter a time of day for the event to begin. Press the Done icon to save the time entered and return to the menu.

Press the Stop Time icon to open a window allowing you to use the numeric icons to enter a time of day for the event to end. Press the Done icon to save the time entered and return to the menu.

Press the Days of Week icon to bring up a screen allowing you to choose the days of the week when the event will be active. The checked days are active.

- A. Use the up and down arrow icons to scroll thru the screens.
- B. Use the Set All icon to check all the days of the week at once.
- C. Use the Clear All icon to uncheck all the days of the week at once.
- D. You do not need to save the choices here, just return to the setup menu for the event by pressing the back arrow icon.

←		🏠		🔑		🔌	
<b>Price Adjust</b>							
Save this event						>	
Remove this event						>	
Enable state						Off	
Frequency						Daily	
Start time						00:00	
Stop time						00:00	
Days of week						>	
Price Adjust Type						Discount	
Price Adjust Percentage						0	
Selections						>	

←		🏠		🔑		🔌	
<b>Days of week</b>							
Set All							
Clear All						√	
Monday							
Tuesday							
Wednesday							
Thursday							
Friday							
Saturday							
Sunday							

Press the Price Adjust Type icon to bring up a screen that allows you to choose the type of price adjustment that is happening. Use the icons to check one. Use the Done icon to lock in the choice and return to the setup menu.

←		🏠		🔑		🔌	
<b>Price Adjust</b>							
Price Adjust Type						Discount	
1) Discount						√	
2) Surcharge							

←		🏠		🔑		🔌	
<b>Price Adjust</b>							
Price Adjust Percentage						0	
Selections						>	

Press the Price Adjust Percentage icon to open a window that will allow you to enter percentage for the price adjustment using the numeric icons. Use the Done icon to lock in the new percentage and return to the menu screen.

Press the Selections icon to bring up a tray list.

<b>Selections for event</b>	
Tray 1	>
Tray 2	>
Tray 3	>
Tray 4	>
Tray 5	>
Add all selections	>

Use the numeric Keys to choose a tray.

<b>Tray #2</b>	
Add all selections	
201	
202	
203	
204	
205	
206	
207	
208	
209	

Choosing a tray will bring up a screen listing all the selections on that tray. Some selection lists may use more than one screen.

Use the up and down arrow icons to scroll thru the entire list.

Use the icons to check or un-check the selections as needed. Checked selections will be involved in the event.

**REMEMBER TO SAVE YOUR SETTINGS OR YOUR WORK WILL BE LOST!**

**2. Press the Free Vend** icon will bring up a screen listing the options for Free Vend.

<b>Time of Day Events</b>	
Price Adjust	>
Free Vend	>
Inhibit	>

<b>Free Vend</b>	
Create Event	>
<p>There is no Free Vend event on this Machine. You can create one if it's needed.</p>	

Press the Create Event icon here will create an event and begin a list of saved events that can be set up as needed.

<b>Free Vend</b>	
Create Event	>
Free Vend #1	>

Use the icons to choose a created event to set up for use and another screen will come up allowing you to configure the event to fit your needs.

<b>Free Vend</b>	
Save This Event	>
Remove This Event	>
Enable State	Off
Frequency	Daily
Start time	00:00
Stop time	00:00
Days of week	>



Press the Save This Event icon to **SAVE your settings** or your work will be lost.

Press the Remove This Event icon to REMOVE the event from memory.

Press the Enable state icon to toggle the setting for the state of the event between ON and OFF.

Press the Frequency icon to toggle the setting for the frequency of the event between DAILY and WEEKLY.

Press the Start time icon to open a window allowing you to use the numeric icons to enter a time of day for the event to begin. Press the Done icon to save the time entered and returns to the menu.

Press the Stop time icon to open a window allowing you to use the numeric icons to enter a time of day for the event to end. Press the Done icon to save the time entered and returns to the menu.

Press the Days of week to bring up a screen allowing you to choose the days of the week when the event will be active. The checked days are active.

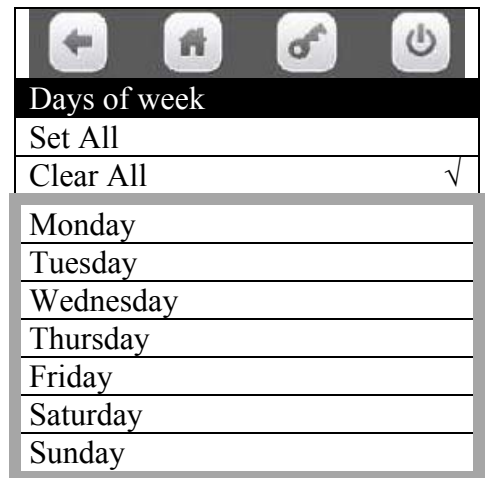

- A. Use the up and down arrow icons to scroll thru the screens.
- B. Use the Set All icon to check all the days of the week at once.
- C. Use the Clear All icon to un-check all the days of the week at once.
- D. You do not need to save the choices here, just return to the set up menu for the event and proceed.

Press the Selections icon to bring up a tray list.

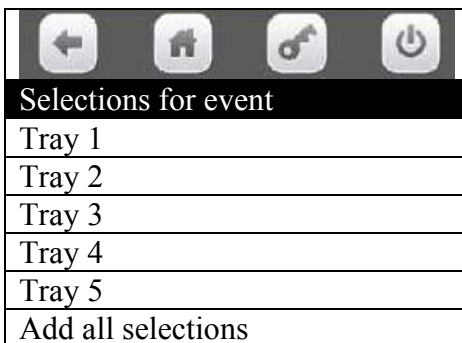

Use the icons to choose a tray.

Choosing a tray will bring up a screen listing all the selections on that tray.

Some selection lists will use more than one screen.  
Use the up and down arrow icons to scroll thru the entire list.

Use the numeric icons to check or un-check the selections as needed. Checked selections will be involved in the event.

**REMEMBER TO SAVE YOUR SETTINGS OR YOUR WORK WILL BE LOST!**

←	🏠	🔑	🔌
<b>Tray #2</b>			
Add all selections			
201			
202			
203			
204			
205			
206			
207			
208			
209			

3. **Press the Inhibit icon** will bring up a screen listing the options for Inhibit.

←	🏠	🔑	🔌
<b>Time of Day Events</b>			
Price Adjust			>
Free Vend			>
Inhibit			>

Press the Create Event icon here will create an event and begin a list of saved events that can be set up as needed.

←	🏠	🔑	🔌
<b>Inhibit</b>			
Create Event			>
There is no inhibit event on this machine. You can create one if it's needed.			

←	🏠	🔑	🔌
<b>Inhibit</b>			
Create			>
Inhibit #1			>
Inhibit #2			>

Use the icons to choose a created event to set up for use and another screen will come up allowing you to configure the event to fit your needs.

←	🏠	🔑	🔌
<b>Inhibit Event</b>			
Save this event			>
Remove this event			>
Enable state		Off	
Frequency		Daily	
Start time		00:00	
Stop time		00:00	
Days of week			>
Selections			>

Press the Save this event icon to **SAVE your settings** or your work will be lost.

Press the Remove this event icon to REMOVE the event from memory.

Press the Enable state icon to toggle the setting for the state of the event between ON and OFF.

Press the Frequency icon to toggle the setting for the frequency of the event between DAILY and WEEKLY.

Press the Start time icon to open a window allowing you to use the numeric icons to enter a time of day for the event to begin. Press the Done icon to save the time entered and returns to the menu.

Press the Stop time icon to open a window allowing you to use the numeric i to enter a time of day for the event to end. Press the Done icon to save the time entered and returns to the menu.

Press the Days of week icon to bring up a screen allowing you to choose the days of the week when the event will be active. The checked days are active.

- A. Use the up and down arrow icons to scroll thru the screens.
- B. Use the Set All icon to check all the days of the week at once.
- C. Use the Clear All icon to un-check all the days of the week at once.
- D. You do not need to save the choices here, just return to the set up menu for the event and proceed.



Press the Selections icon to bring up a tray list.

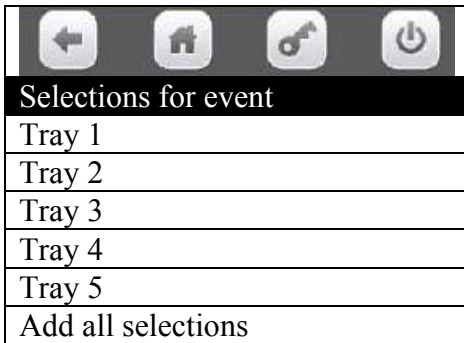

Use the icons to choose a tray.

Choosing a tray will bring up a screen listing all the selections on that tray.

Some selection lists will use more than one screen. Use the up and down arrow icons to scroll thru the entire list.

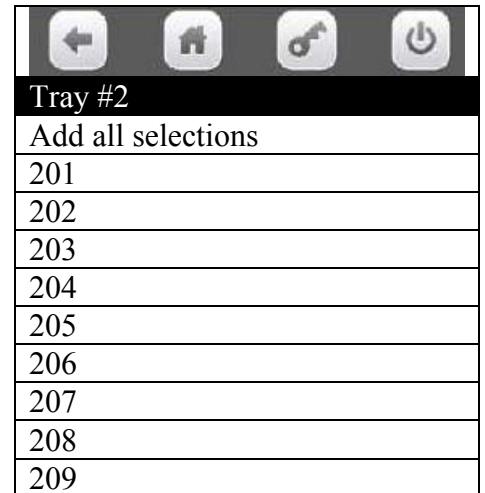

Use the icons to check or un-check the selections as needed. Checked selections will be involved in the event.

**REMEMBER TO SAVE YOUR SETTINGS OR YOUR WORK WILL BE LOST!**

**2. Press the Backup Events icon will bring up the first screen for Backup Events.**



Press the Backup Events icon will bring up a screen allowing you to set up a timed backup of events.

Press the Save this event icon to **SAVE your settings** or your work will be lost.

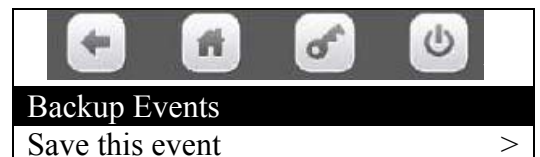

Press the Enable state icon to toggle the setting for the state of the event between ON and OFF.

Enable state	<input type="checkbox"/>	Off
Start time		00:00
Days of week		>

Press the Start time icon to open a window allowing you to use the numeric icons to enter a time of day for the event to begin.

Press the Done icon to save the time entered and returns to the menu.

Press the Days of week icon to bring up a screen allowing you to choose the days of the week when the event will be active. The checked days are active.

- A. Use the up and down arrow icons to scroll thru the screens.
- B. Use the Set All icon to check all the days of the week at once.
- C. Use the Clear All icon to un-check all the days of the week at once.
- D. You do not need to save the choices here, just return to the set up menu for the event and proceed.

←		🏠		🔑		🔌	
Days of week							
Set All							
Clear All							
Monday							
Tuesday							
Wednesday							
Thursday							
Friday							
Saturday							
Sunday							

**REMEMBER TO SAVE YOUR SETTINGS OR YOUR WORK WILL BE LOST!**

**3. Press the Power Saving Events icon will bring up the first screen for Power Saving events.**

←		🏠		🔑		🔌	
Timed Events							
Time of Day Events >							
Backup Events >							
Power Saving Events >							

Press the Power Saving Events icon will bring up a screen allowing you to set up timed power saving events.

Press the Create Event icon here will create an event and begin a list of saved events that can be set up as needed.

Use the icons to choose a created event to set up for use and another screen will come up allowing you to configure the event to fit your needs.

←		🏠		🔑		🔌	
Power Save Events							
Create Event >							
Power Save #1 >							
Light Timer >							

←		🏠		🔑		🔌	
Power Save Events							
Save this event >							
Remove this event >							
Enable state <input type="checkbox"/> Off							
Frequency <input type="checkbox"/> Daily							
Start time 00:00							
Stop time 00:00							
Days of week >							

Inactivity Minutes

Press the Save this event icon to **SAVE your settings** or your work will be lost.

Press the Remove this event icon to REMOVE the event from memory.

Press the Enable state icon to toggle the setting for the state of the event between ON and OFF.

Press the Frequency icon to toggle the setting for the frequency of the event between DAILY and WEEKLY.

Press the Start time icon to open a window allowing you to use the numeric icons to enter a time of day for the event to begin. Press the Done icon to save the time entered and return to the menu.

Press the Stop time icon to open a window allowing you to use the numeric icons to enter a time of day for the event to end. Press the Done icon to save the time entered and return to the menu.

Press the Day of week icon to bring up a screen allowing you to choose the days of the week when the event will be active. The checked days are active.

- A. Use the up and down arrow icons to scroll thru the screens.
- B. Use the Set All icon to check all the days of the week at once.
- C. Use the Clear All icon to un-check all the days of the week at once.
- D. You do not need to save the choices here, just return to the set up menu for the event and proceed.



Press the Inactivity Minutes icon to open a window allowing you to use the numeric icons to enter a number of minutes that the vender goes with no activity before the power save will enable and turn off the lights and also changes the Refrigeration Set Point to the Storage Set Point value. Default setting is 0.

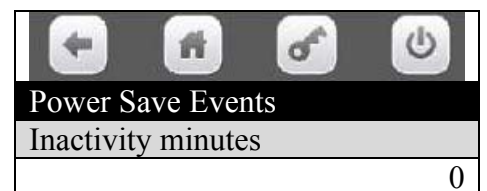

Press the Light Timer icon to open a window allowing you to use the numeric icons to enter a number of hours that the vender goes with no activity before the power save will enable and turn off the lights. Default setting is 10 hours. This may not be disabled and is independent from the Power supply events.



**REMEMBER TO SAVE YOUR SETTINGS OR YOUR WORK WILL BE LOST!**

## TELEMETRY.....Press the icon to bring up the first screen.

Press the zero Telemetry icon will bring up the first screen listing the telemetry options.

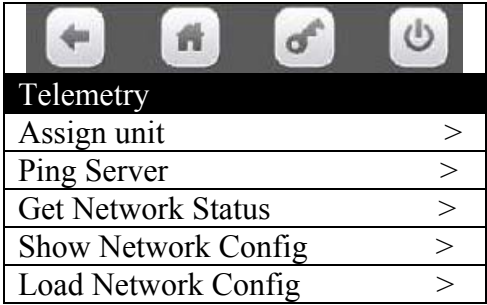

Use the icons to choose an option.

Choosing an option will bring up the first screen for that option.

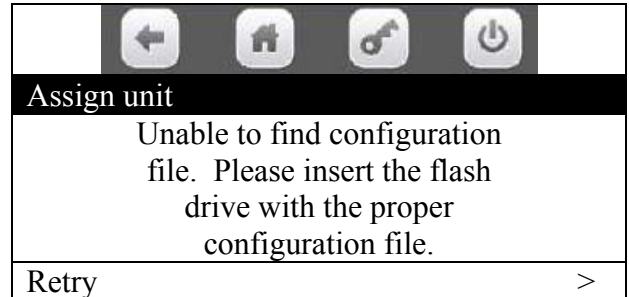

1. **Press the Assign unit** icon to Assign a Unit.

## ASSIGNING AN ATLAS UNIT (board)

Required items for assigning an Atlas Unit via onboard Telemetry Service Mode menu:

1. A USB flash memory stick.
2. A folder must be created on the flash memory stick and named “atlas”.
3. A file must be copied and pasted in the atlas folder. (VIXConfigData.cfg)
4. The file is received by e-mail after setting up an account with Streamware.

## A DESCRIPTION OF THE PROCESS

When the “Assign unit” icon is pressed in the service mode function named “Telemetry”, the assignment process looks for the (VIXConfigData.cfg) file in the “atlas” folder on the USB flash memory stick.

1. The assignment process will automatically look for the VIXConfigData.cfg file and can also allow the user to select a different file. The relevant parameters from the selected file will be displayed so that the user can confirm that the correct values are being set.
2. If the file is not present, the user is notified of this fact and the process will go no further.
3. If the file is present, it is loaded and the configuration values are compared to the currently loaded configuration values in the Atlas Board.

If any of the required parameters are different, the new parameters are loaded and the machine is no longer rebooted after the configuration parameters are loaded. Instead, the telemetry agents are reset and the assignment process is then automatically continued without having to reenter Service Mode. This will verify the customer identification and user entered fields to the server and finalize the assignment process. The process can be halted at each step if an error is encountered. Errors will be displayed to the user with as much detail as possible. In many cases, simply re-trying the current operation will successfully complete the operation, especially if the error was caused by a communications interruption. In order to re-try an operation, the user must press the back arrow icon at the top of the menu structure when the error status is displayed.

Again, the machine is no longer rebooted after the assignment process is completed. The telemetry agents will be reset to complete the assignment process. When the button the reset the agents is shown,

then the process is complete: no further waiting is necessary (the wait was required because of an issue in the 10.6.X releases).

## ASSIGN STEPS - A path for success

1. Insert a prepared USB flash memory stick into the USB port 3 on the Atlas Board.
2. Enter the service mode and press the icon to go into the “Telemetry” menu.
3. Press the icon to enter the “Assign Unit” function.
- A. If the values in the new file on the stick are different than the current values in the Board, the new values will be loaded into the board and the telemetry agents will be reset rather than rebooting the machine.
- B. After the telemetry agents are reset, the process will automatically enter the ‘Verify Customer ID’ section.
- C. With the new configuration successfully loaded, a screen will come up displaying “Verify Customer ID” icon. Press this icon to verify the customer ID with the server.
- D. When the customer ID is verified successfully, a screen will come up displaying a “Set User Fields” icon. Press this icon to display the fields that need to have data entered by the user.
- E. Each user field will have a icon that will allow the user to enter or edit the data in that field. As of now, there is only one required field that must be filled in. Press the icon for the field “Machine ID”. This will allow the user to enter the machine identification number for the machine being assigned.

Note – when assigning a Bevmax Media embedded onboard card reader for an existing Streamware Vend Max customer, you must use their machine/equipment asset number. Any other Machine ID such as the machine serial number will cause the assign process to be invalid.

4. When the user has completed entering data into the fields, a “Validate Entries” icon will appear. Pressing this icon will send all the user fields to the server for validation.
5. When the user validation is successful, a “Finalize Assign” icon will appear. Press this icon to finalize the assignment process with the server.
6. When the finalization process is completed, in the 10.8.X release & higher the System Time will be checked against the value in DMS. If the time has changed, then the system will reboot. Otherwise, only the telemetry agents will be reset. There will be three possible messages on this final button:
  - a. Unit is assigned. System time is correct. Remove the flash drive. Press the button to reset the agents.
  - b. Unit is assigned. Unable to update the system time. Remove the flash drive. Press the button to reset the agents.
  - c. Unit is assigned. System time as been updated. The system will now reboot to complete the time update.

2. **Press the Ping Server** icon will cause the machine to attempt to Ping the Server.

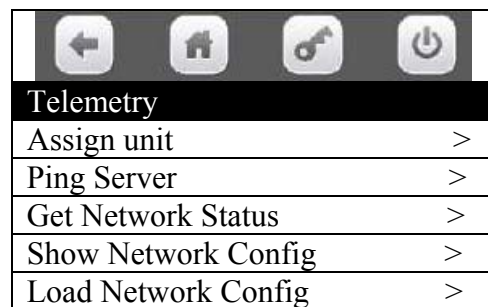

Ping Server

Failed

If the machine is not able to do so, it will report “ Failed”.

A ‘Failed’ status means exactly that. The attempt to communicate with the server was not successful. This can be due to the radio being unable to attach to the cellular network, a hardware error with the telemetry system, an invalid URL in the configuration file, or the server itself may be down.

3. **Press the Get Network Status** icon to Get Network Status.

	
<b>Network Status</b>	
Node type :	No Mesh Network (Client)
AID:	
Network flags: (##)	
Last error: (0)	
Adaptor type:	none
Net type:	No Adaptor
	Not Applicable
IP :	Not Applicable
URL :	http://streamwareonline.com:8081/WANServiceSB.asmx
ESN :	Not Applicable
Sim ID:	Not Applicable
BT:	

**Get Network Status Screen**

Node types can be:

**No Mesh Network** (no mesh network hardware or radio installed).

**Gateway** (radio and mesh network hardware is installed).

**Client** (mesh network, but no radio, is installed).

**Solo** (radio, but no mesh network, installed).

AID: is the Asset ID given to the machine when it is assigned.

Network flags: is a bitmapped field showing the status of the network.

Adaptor type: shows the type of radio installed (none, CCM, GSM, CDMA, Ethernet, or undefined).

Net Type: identifies the radio type that is plugged into the VMC. It will read either GSM or CDMA if a radio is present. If the radio is unplugged it will read No Adaptor.

IP: is the IP address of the machine if it’s assigned.

URL: is the URL for the DMS that handles the SOAP calls from the machine.

ESN: is electronic serial number of the radio.

Sim ID: is the ID of the SIM card in the radio.

BT: is a holdover from the Bluetooth days and is not currently used.

4. **Press the Show network Config icon** to Show Network Configuration data.

URL: is the address for the DMS that handles the SOAP calls from the machine.

GSM APN: is the Access Point Name used by the GSM radio.

GSM User: is the username used by the GSM radio.

GSM Password: is the password used by the GSM radio.

Zigbee Pan ID: is one of the Zigbee parameters that identify the mesh network.

Zigbee Net Key Seed: is the other Zigbee parameter used to identify the mesh network.

	
<b>Network Configuration</b>	
URL :	http://streamwareonline.com:8081/WANServiceSB.asmx
GSM APN:	attz.cranems.com
GSM User:	
GSM Password:	
Zigbee Pan ID:	(0)
Zigbee Net Key Seed:	(0)



5. **Press the Load network Config** icon to Load Network Configuration.



If the “Flash stick not found” message is displayed, the system cannot detect that a USB stick has been inserted into the Atlas board. Make sure the USB stick is properly formatted and contains an /atlas folder.

### **BevMax/Merchant Media Intergraded Wireless Radio Setup Cashless / Remote DEX / Alerts**

1. Heartland / Streamware Acct - Before installing the radio for intergraded wireless function, you must establish an account with Vantiv or Heartland Payment Systems and Crane Streamware.
  - A. When the customer account is established, Crane Streamware will email the customer a configuration file for uploading and assigning the BevMax Media (referenced as BMM below).
2. On the BMM, check/load the Control Board software. It should be version 10.6.10 or higher.
3. On the BMM, check/set the current Time and Date.
4. **Make sure the machine fully operates and vends product before proceeding.**
5. On Atlas Control Board, make sure J27 has a jumper across pins 2 & 3.
6. On the BMM, set cashless reader to “Onboard Reader”
  - A. In Service Mode, go into Monetary Menu.
  - B. At Cashless Reader, select “Onboard Reader”
7. Radio Installation
  - A. On the BMM, turn OFF the power switch.
  - B. Connect the USB cable between the Radio and USB1 on the Atlas Control board. USB1 is located at top left of other two USB sockets facing the board.  
**\*\*\* Very Important \*\*\*** The Radio will only work in USB1, not USB2 or USB3.
  - C. Connect the antenna’s to the Radio
  - D. Velcro the Radio assembly against the cover panel of the control board.
  - E. On the BMM, turn ON the power switch.
  - F. Within a couple of minutes the LED on the radio should flash or stay lit.
  - G. Neatly route and tie wrap all the Radio cables in order to prevent them from catching/pinching when closing the monetary panel.
8. Download the customer configuration file on the USB memory stick.
  - A. Use a blank USB memory stick and plug it into your computer.
  - B. When account and machine information is established by Vantiv or Heartland and Streamware, they will email the following customer configuration file: “VixConfigData.cfg”.

- C. Open up the computer drive where the USB memory stick is inserted.
  - D. Create a new folder called “**atlas**” on your blank USB stick.
  - E. Copy the emailed file “VixConfigData.cfg” and paste into the “**atlas**” folder.
9. Check Radio signal strength.
- A. In Service menu, press “Telemetry” icon.
  - B. Press “Get Network Status” icon.
  - C. The first line should show **Node Type**: “Gateway”. If it shows “Client” the radio is not communicating with the board.
  - D. Check the RSSI parameter line on screen. If the signal strength is very low (above -100 DB), you might consider switching to a different radio type (i.e., GSM vs. CDMA or vice-versa).
10. Assigning Telemetry:
- A. Depress the Monetary Panel interlock switch and wait for security pin entry to appear on display. Enter four digit pin (factory default = 3333).
  - B. Insert USB memory stick into any open USB port on control board.
  - C. At Service Menu screen, press the “Telemetry” icon.
  - D. In Telemetry screen, press the “Assign Unit” icon.
  - E. Reboot is no longer done at this point. The telemetry agents are reset if the configuration changes. (*Note: Wait at least 5 minutes to fully allow upload and reboot.*)
  - F. The following screen should appear:
    - Press Machine ID icon and enter the machine ID

\Assign init\Assign unit Please enter values for each of the fields below. Selecting the button will bring up an editor for entering values.	
Machine ID	

\Assign unit\Assign unit Machine ID						
A	B	C	D	E	F	G
H	I	J	K	L	M	N
O	P	Q	R	S	T	U
V	W	X	Y	Z	←	
123	Aa	#@		X	Done	

The Machine ID Keypad will be similar to a text type phone that does not have a full keyboard. Press 123 button to change the keypad character function to Numeric or the Aa to switch from Alpha: Upper Case to Alpha Lower Case. Example machine ID 34585 (p= pause for .5 seconds):

- G. Press Validate Entries icon. This step will validate the Machine ID entered.

\Assign init\Assign unit Please enter values for each of the fields below. Selecting the button will bring up an editor for entering values.	
Machine ID	SMV002
Validate Entries	

- Machine ID is validating user information

- Machine ID validated and assignment complete

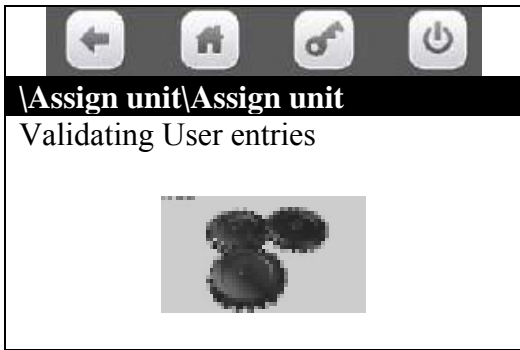

- H. Press Reboot to complete Assign icon to reboot machine and complete assignment process.

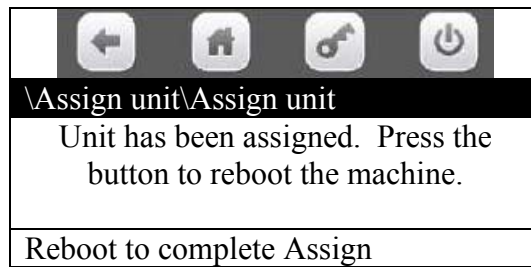

- I. Upon reboot, remove USB memory stick from the Atlas Control Board.  
J. Test machine for wireless operation.

## TELEMETRY – How it Works

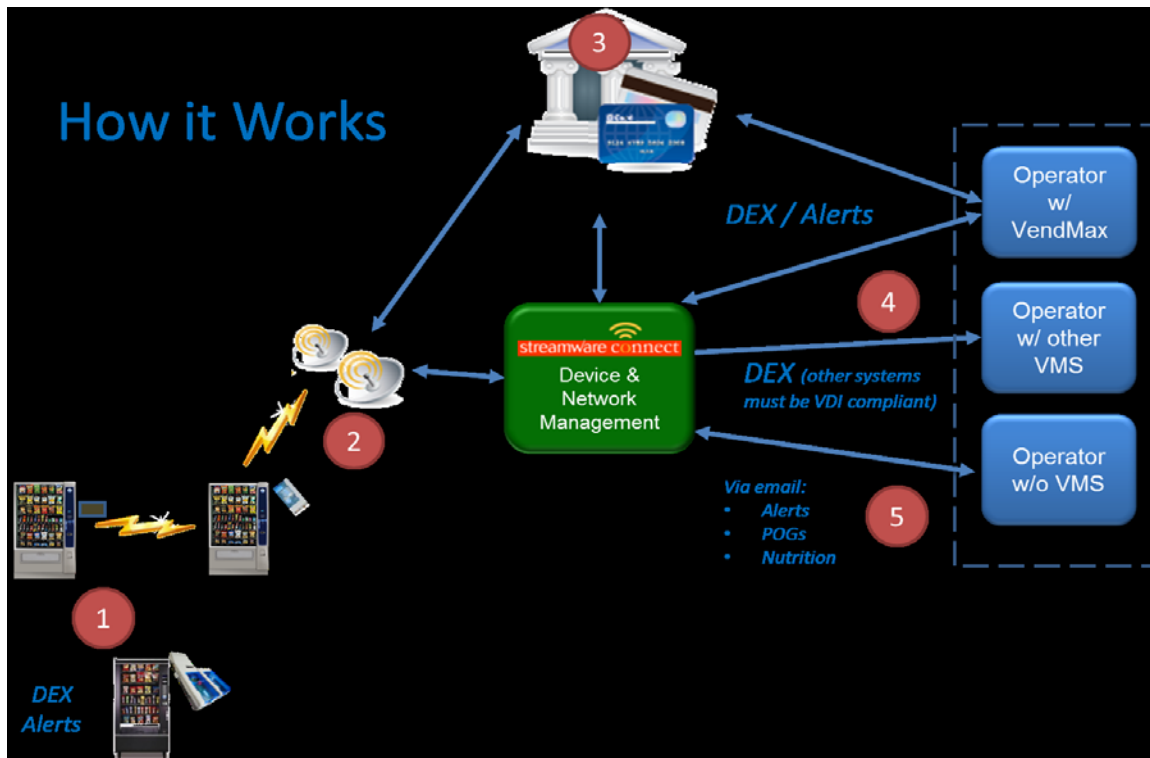

### Telemetry Devices come in 3 packages.

1. **Clients** – Telemetry units that only contain ZigBee chips installed to communicate to a Gateway Telemetry unit.
2. **Gateways** – Telemetry units that have both ZigBee chips for Mesh network communication and cell Radios (GSM or CDMA) for cell network communication.
3. **Solo** – Telemetry units that only contain Cell radios for cell network communication, no ZigBee ship for mesh communication.

① The Navigator or merchant Media onboard Telemetry devices query the Vending machine for DEX file information on a predetermined schedule. This is done 2 times per day, generally in the AM – 2am and again in the PM – 2pm.

Machine alerts are processed upon receipt by the telemetry devices and sent to the Operators VendMAX system or by email to non-VendMAX users.

② The Gateway Navigator or Merchant media Machine onboard Gateway device receives DEX, and machine Alert information from the Client devices on its mesh network. It then transmits the information over the cell network to Streamware Connect for storage and processing.

③ Credit Card Transaction, data is sent to the Credit card processor (Vantiv, Heartland) for Credit Card validation and processing. If the card is valid, an acknowledgement is returned to the Vending machine and the product is vended. If not, a denied acknowledgement is returned to the Vending Machine and no vend takes place until a valid card is used. The same information both Denied and Validated, are sent to Streamware Connect where it is stored in the Consumer Insight report of the specific Operator. This report captures and stores all transaction data and the results of the transaction for both Credit Cards and Cash transactions. The Operator receives monthly statements with detail on

all transactions, Number of, Price per transaction, etc. from the Card Processing Company (Vantiv, Heartland). Daily Transactional data is sent from Vantiv or Heartland to the operators VendMAX system for automated reconciliation.

④ All DEX, Machine alerts, and Transactional history is pulled from Streamware Connects server by the Operators VendMAX system and stored in the VendMAX database for processing.

Streamware Connect supports the VDI Standard which allows for operability with other VMS systems that are VDI compatible. This pertains to DEX files only; VendMAX is the only VMS that performs cashless transaction reconciliation. VDI support is only available for DEX file transfers to VDI compliant VMS, NOT cashless transactions. Only VendMAX provides support for Cashless reconciliation.

⑤ For Merchant Media machines, all plan-o-gram, Nutritional information, and product graphics are generated by Streamware Connect. Crane Merchandising Systems is providing the nutritional content information based on information provided by the product manufacturers and Crane Merchandising Systems cannot accept responsibility for content created by others.

The generated output files are sent via email to the Operator for inclusion on a flash drive for upload to the Merchant Media Machine.\*\*

Alerts received from Vending Machines are routed via email to non-VendMAX customers.

\*\*At the time of purchase, Streamware Connect sends the Operator a welcome package with all templates and instructions for filling out the plan-o-gram template and where they send it once it's complete for processing.

### **Definitions:**

DEX – stands for Data Exchange and is uniform data that allows vending machines to report information to data collection systems.

Alerts – provide operators with information (Machine Alerts) about the Vending Equipment's operations. Examples: Door open, Temperature sensing, Coin Tube Empty, Inventory levels, etc. these alerts are real-time alerts separate from DEX reports.

POG – Plan-O-Gram, contains Product descriptions, UPC Codes, prices, Column/Spiral locations, MAX quantity and planned quantity for each column/spiral locations for the inventory being sold in each Vending Machine.

Nutritional information – Calories, Carbohydrates, Protein, Sodium, total Fat, Saturated Fats for each product being sold in the vending machine. Crane Merchandising Systems is providing the nutritional content information based on information provided by the product manufacturers and Crane Merchandising Systems cannot accept responsibility for content created by others.

GSM – Global System for Mobile Communications, is used by AT&T and T-Mobile as their method for Cell communication.

CDMA – Code division multiple access, is used by Verizon and Sprint at their method for Cell communication.

ZigBee – is a proprietary wireless network that Crane Merchandising Systems uses for Mesh communication. This network is used for Telemetry device, Client to Gateway communication, Gateway to Client communication.

Credit Card Processing – Payment processing to accept credit/debit card payments for product purchases. Using a Payment Processor such as Vantiv or Heartland provides the Operator with all the services necessary to give consumers a secondary means of payment. Merchant accounts and terminal ID's, card processing and validation and transaction processing from card Swipe to the Operators bank account.

Credit Card Settlement – Better known as Credit Card Reconciliation, it's the method of balancing the amount of dollars collected and balancing it against the amount of product sold. Just like balancing your check book but totally automated using VendMAX.

Streamware Connect – simply stated, Streamware Connect provides telemetry devices and infrastructure to reliably pass both Transactional and operational data about Vending machines from one software application to another, so that multiple applications can contribute to a comprehensive, networked solution.

With or without a vending management system, Streamware Connect lets you manage your Media Machine content including plan-o-grams, nutritional information, pricing, and marketing content. It also lets you receive alerts – learn if your payment system doesn't have change or your Media Machine reached your cash limit (or many other potential alerts) via email.

Streamware Connect also maintains a state of the art server farm located in a remote co-location facility with redundant power, networks, and on-site support. The infrastructure serves the entire installed base of telemetry devices and the communications to and from the operators VendMAX systems.

Navigator – the telemetry device that receives information from the Vending machine and transmits the files across the cell network and internet to Streamware Connect, the Credit card Processor, and to the Operators VendMAX or other VDI compliant VMS.

VMS – Vendor Management System. A process or system for managing vending machines such as VendMAX.

VDI – Vending Data Interchange. A NAMA standard for monitoring 2 types of data: Transactional data includes product selection, pricing, sales, and payments while Operational data involves error messages, conditional alerts, and malfunction reporting.

Media – Crane Merchandising Systems new equipment platform is the industry's most advanced vending solution. Built on NAMA Open Standards, Media integrates the following capabilities in to one powerful solution: graphics, touch screens, consumer insights data, advertising, and promotions, social media, networking options (including machine to machine, cellular, & Ethernet), cashless payment options including mobile wallet, USB peripherals, and much more.

VendMAX – our VendMAX customers can take advantage of a whole new level of business integration with Media including: route efficiency optimization, cash and cashless reconciliation, machine alert prioritization and resolution, merchandising, and many more benefits.

## MACHINE CONFIGURATION...Press the icon to bring up the first screen.

Pressing the Machine Configuration icon brings up a screen listing the Machine Configuration menu items. Note: Of the items listed below, Firmware Information on this initial screen is view only and cannot be changed at this point in the programming. They are for information purposes only. They may be changed at other menu locations in the programming.

Machine Configuration	
Refrigeration Settings	>
Space To Sales	Off
Picker Cup Sensor	On
Port Sensor	On
Manual Key Switch Override	>
Firmware Information	>
Cabinet Offsets	>
EVS Compliance	No
Shelf Location	D2
Model Number	5800
Encoder Resolution	3310 counts/inch

### Refrigeration Settings – Press the Refrigeration Settings icon.

Pressing the icon will bring up options for controlling the temperature and health control settings. When the health control features are not in use the control options will not appear.

Refrigeration Settings	
Refrigeration Set Point	50°F
Storage Set Point	45°F
Recheck Allowed	Yes
Temperature Units	Fahrenheit (°F)
Health Control	>

Press an icon to choose the desired option. Choosing the desired option will either bring up a screen or open a window to proceed.

**Press the Refrigeration Set Point** icon will open up a window allowing you to set a new temperature (set point) for initial pull down and reload recovery using numeric icons. The vender leaves the factory set at 37°F (temperature set must be between 32° and 75° F or 0° and 23.8° C). Use the Done icon to lock in the new setting.

**Press the Storage Set Point** icon will open up a window allowing you to set a new temperature (set point) for storage temperature using the numeric icons. The vender leaves the factory set at 45°F (temperature set must be between 32° and 75° F or 0° and 23.8° C). Use the Done icon to lock in the new setting. Storage time must be set and Storage Temp Enabled for this Temperature setting to work.

**Press the Recheck Allowed** icon will toggle Recheck Allowed from Yes to No. When set to Yes after a “HEALTH TIME” error has occurred, the vender will recheck the cooler compartment temperature 3 times in 15-minute intervals. If the temperature drops below 41°F, the “HEALTH TIME” error is cleared and selections are re-enabled. If any recheck reads above a previous reading, or if the temperature is not below 41°F by the third recheck, the “HEALTH TIME” error will remain and selections will continue to be blocked.

**Press the Temperature Units** icon to bring up a screen that allows you to choose the type of Temperature Units you would like to display. Use the icons to check one. Use the Done icon to lock in the choice and return to the setup menu.

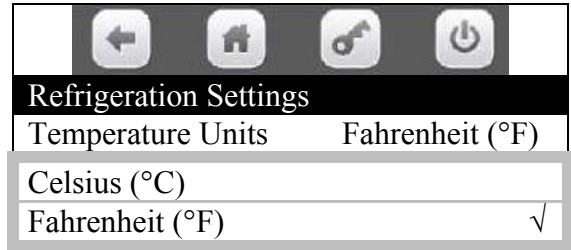

**Press the Health Control** icon will bring up a screen listing the Health Control options. When enabled, if the temperature in the vender does not reach 41° F (5° C) within 30 minutes after the service door is closed, a “HEALTH TIME” error will occur and lockout the enabled selection(s) from vending until after the error is cleared. Also, if the temperature in the vender goes above 41° F (5° C) for more than 15 minutes after the initial cool down period, a “HEALTH CONTROL” error will occur and lockout the enabled selection(s) from vending until the error is cleared.

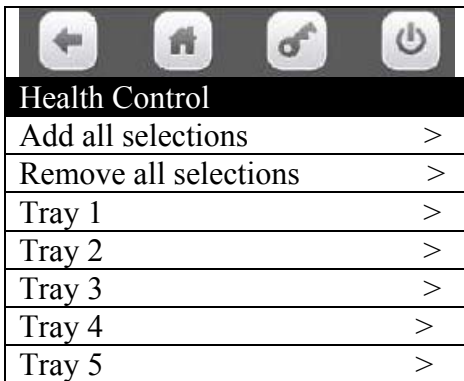

To set selections for Health Control Press the Health Control icon. Use the icons to choose a tray. Choosing a tray will bring up a screen listing all the selections on that tray. Some selection lists will use more than one screen. Use the up and down arrow icons to scroll thru the entire list. Use the icons to check or un-check the selections as needed. Checked selections will be involved in the event.

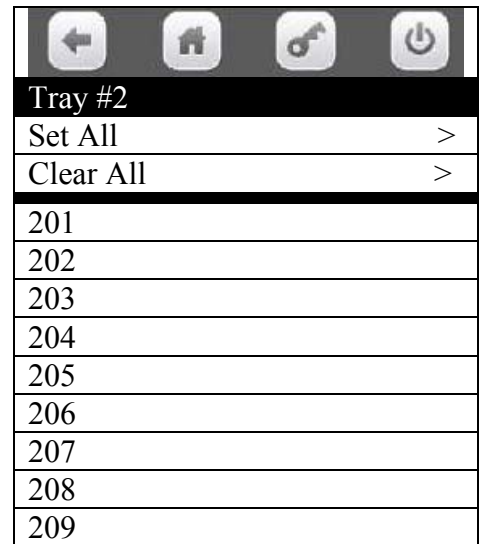

**Space To Sales – Press the Space To Sales icon.**

Pressing the Space To Sales icon will toggle the Space to Sales setting on and off.

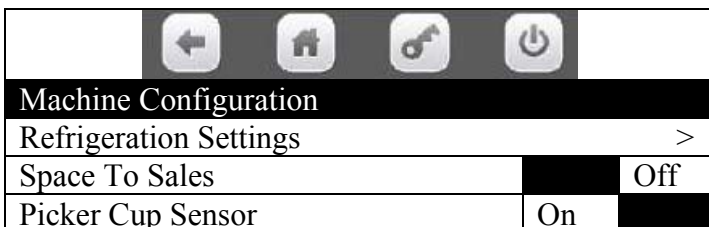

Use the icon to toggle the setting between ON and OFF. The default setting for this option is ON.



**Picker Cup Sensor – Press the Picker cup Sensor icon.**

Pressing the Picker Cup Sensor icon will toggle the Picker (Delivery) Cup Sensor setting on and off.

<b>Machine Configuration</b>		
Refrigeration Settings		>
Space To sales	<input type="checkbox"/>	Off
Picker Cup Sensor	<input checked="" type="checkbox"/>	On

Use the icon to toggle the setting between ON and OFF. The default setting for this option is ON.

**Port Sensor – Press the Port Sensor icon.**

Pressing the Port Sensor icon will toggle the Port Sensor setting on and off.

<b>Machine Configuration</b>		
Refrigeration Settings		>
Space To sales	<input type="checkbox"/>	Off
Picker Cup Sensor	<input checked="" type="checkbox"/>	On
Port Sensor	<input checked="" type="checkbox"/>	On
Manual Key Switch Override		>

Use the icon to toggle the setting between ON and OFF. The default setting for this option is ON.

**Manual Key Switch – Press the Manual Key Switch Override icon.**

Pressing the Manual Key Switch Override icon will bring up a list of options that may be checked to override their setting with a manual key switch.

<b>Manual Key Switch Override</b>		
No Vend	<input type="checkbox"/>	
Free Vend	<input type="checkbox"/>	
Discount	<input type="checkbox"/>	
Block	<input type="checkbox"/>	
Light	<input type="checkbox"/>	
Refrigeration	<input type="checkbox"/>	

Press an icon for an individual selection will check or un-check that selection to be affected when the manual key switch override is turned to the on or off position.

**No Vend** when checked and Manual Key Switch Override is on will not allow vending of anything.

**Free Vend** when checked and Manual Key Switch Override is on will allow free vends to occur, unless the No Vend override is also checked. In that case, No Vend will override the Free Vend setting.

**Discount** when checked and Manual Key Switch Override is on will not allow Discounted vends to occur, even when discounted vends is set to occur. Discount prices are set in Timed Events Menu or Special Vend Modes Menu.

**Block** when checked and Manual Key Switch Override is on will prevent selections from being blocked.

**Light** when checked and Manual Key Switch Override is on turn the vertical lights on.

**Refrigeration** when checked and Manual Key Switch Override is on will override any power save that is in effect for the machine. In other words, it will refrigerate to the regular set point instead of the storage point.

**Firmware Information – Press the Firmware Information icon.**

Pressing the Firmware Information icon will bring up information for firmware for different peripherals in the machine.

<b>Firmware Information</b>		
Bill Validator		
SMV-US-MDB	CCD	0254
Cashless		
No MDB Card Reader	-/-	-/-
Onboard Disabled	-/-	-/-
Coin Mechanism		
C2Pv0 1 455	NRI	0200
LE Board	Ver	Kernel
10000104000	10.6.10	2.6.34 V7.7
IO Board Version	0030	
Cashless processor		

Shown is a sample of what would be displayed in a vender with a Currenza C2 Coin Mech, Currenza Validator, no card reader, LE (Control) Board, control board software version, and the Kernel (Linux Operating System) version.

Press the back arrow icon to return to Machine Configuration.

**Cabinet Offsets – Press the Cabinet Offsets icon.**

Pressing the Cabinet Offsets icon will bring up information for current offset settings and allow you to open windows to change the settings and to test the Swipe Position of the Delivery Cup as needed.

<b>Cabinet Offsets</b>	
Valid values for the hook Swipe position are between 81704 and 105052.	
Move to Swipe Position	>
Hook Offset	93500
Shelf Offset	700

**Press the Move to Swipe Position** icon with the left door switch pulled to the out position will allow the Delivery Cup to move to the Port location as if it were making a delivery.

**Press the Hook Offset** icon will open a window allowing you to use the numeric icons to enter a setting for the Hook of the Delivery Cup on the Port frame to occur. Press the Done icon to save the setting entered and return to the menu.

**Press the Shelf Offset** icon will open a window allowing you to use the numeric icons to enter a setting for the Delivery Cup alignment to the Shelf to occur. Press the

Done icon to save the setting entered and return to the menu.

**EVS Compliance – Press the EVS Compliance icon.**

Pressing the EVS Compliance icon will not change setting. This screen is view only and cannot be changed. It is for information purposes only.

**Shelf Location – Press the Shelf Location icon.**

Pressing the Shelf Location icon will not change setting. This screen is view only and cannot be changed at this point in the programming. It is for information purposes only. It may be changed at other menu locations in the programming.

**Model Number – Press the Model Number icon.**

Pressing the Model Number icon will not change setting. This screen is view only and cannot be changed at this point in the programming. It is for information purposes only. It may be changed at other menu locations in the programming.

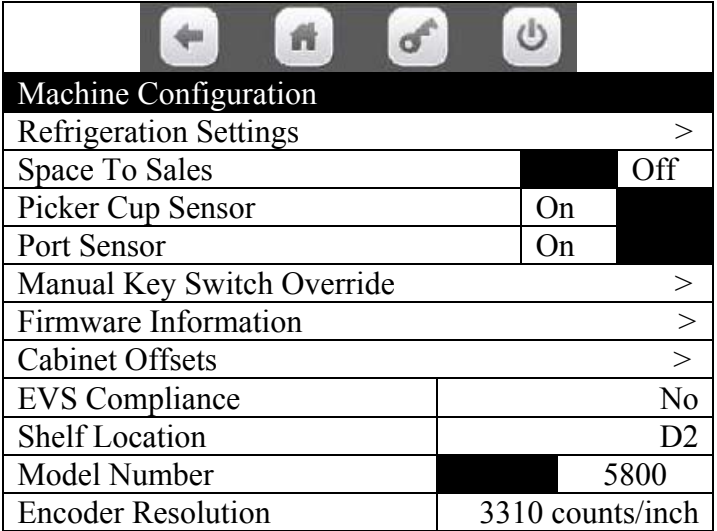

Machine Configuration		
Refrigeration Settings >		
Space To Sales		Off
Picker Cup Sensor	On	
Port Sensor	On	
Manual Key Switch Override >		
Firmware Information >		
Cabinet Offsets >		
EVS Compliance		No
Shelf Location		D2
Model Number		5800
Encoder Resolution		3310 counts/inch

**Encoder Resolution – Press the Encoder Resolution icon.**

Pressing the Encoder Resolution icon will not change setting. This screen is view only and cannot be changed. It is for information purposes only.

## BevMax 6 Media LED Driver Board Assembly (CR0014114)

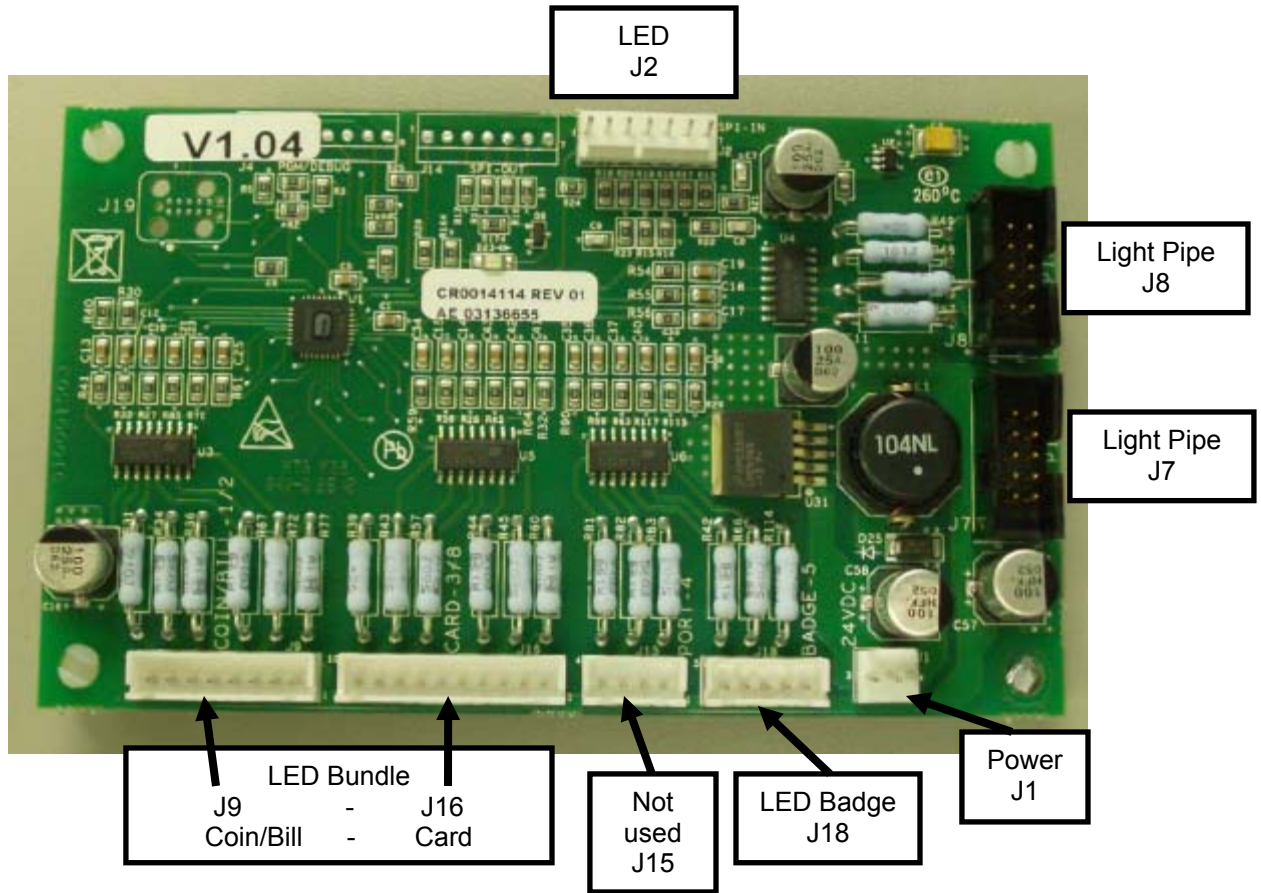

### BEVMAX 6 DN5800-6/3800-6/5800-E6/3800-E6 LED DRIVER BOARD ASSEMBLY CONNECTIONS

CONNECTION	DESCRIPTION	COMMENTS
J1	LED Controller Power	From interior power harness to LED Driver board assy. (24VDC)
J2	LED Control	From Atlas Board to LED Driver Board
J7	Light Engine	Light Engine to J7
J8	Light Engine	Light Engine to J8
J9/J16	LED Bundle	From J16 & J9 LED Driver Board to PCB LED at coin insert, bill validator, and cashless openings.
J15	Port 4	Not used at this time.
J18	LED Badge	From J18 to PCB LED Assy. behind top of pill.

### BevMax 6 Media I/O Board (CR0014121)

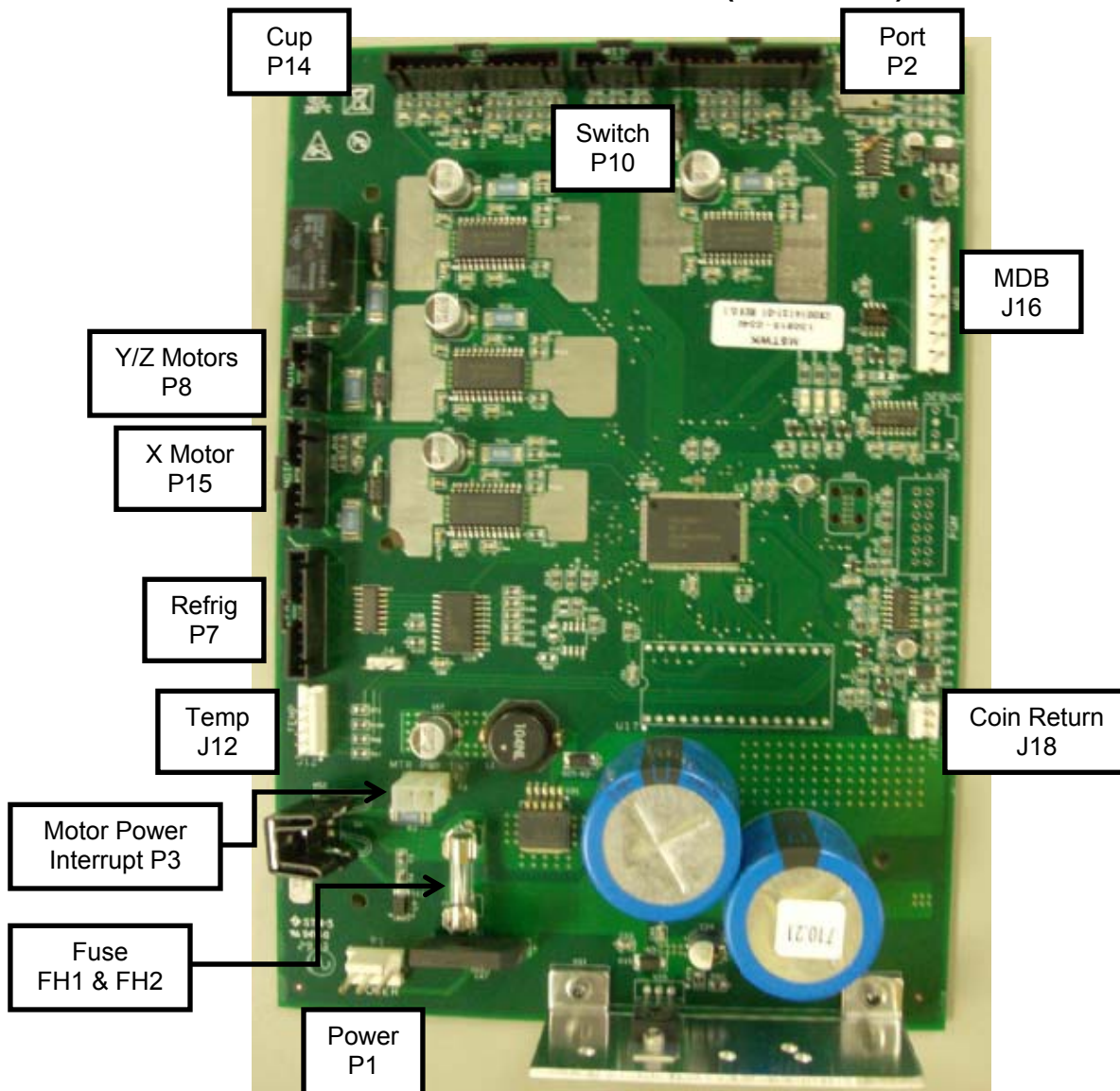

BEVMAX 6 DN5800-6/3800-6/5800-E6/3800-E6 I/O BOARD CONNECTIONS

CONNECTION	DESCRIPTION	COMMENTS	CONNECTION	DESCRIPTION	COMMENTS
P1	Power	Power from AC Distribution Box	FH1 & FH2	Fuse	3AMP/250V
P2	Port				
P3	Motor Power Interrupt		J12	Temp	
P7	Refrigeration		J16	MDB	
P8	Y/Z Motors		J18	Coin Return	
P10	Switch				
P14	Y/Z Motors				
P15	X Motor				

**BevMax 6 Media Atlas Board  
(CR0022933 Touch)  
(Does not include software)**

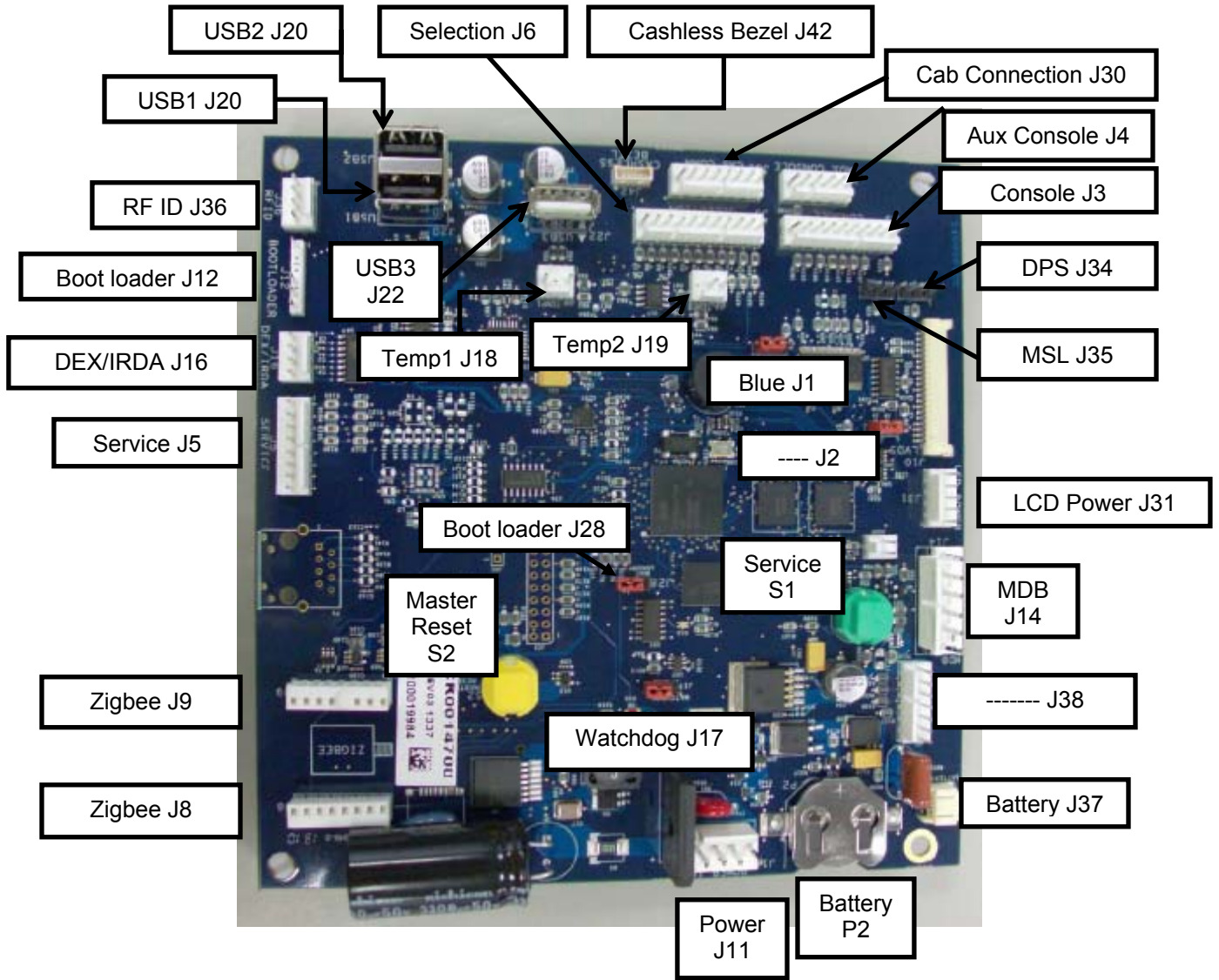

BEVMAX 6 DN5800-6/3800-6/5800-E6/3800-E6 ATLAS BOARD CONNECTIONS

CONNECTION	DESCRIPTION	CONNECTION	DESCRIPTION	CONNECTION	DESCRIPTION
J1	Blue	J16	DEX/IRDA	J36	RF ID
J2	-----	J17	Watchdog	J37	Battery
J3	Console	J18	Temp1	J38	-----
J4	Aux Console	J19	Temp2	J42	Cashless Bezel
J5	Service	J20	USB1 & USB2		
J6	Selection	J22	USB3	P2	Battery
J8	Zigbee	J28	Boot loader	S1	Service
J9	Zigbee	J30	Cab Connection	S2	Master Reset
J11	Power	J31	LCD Power		
J12	Boot loader	J34	DPS		
J14	MDB	J35	MSL		

## BEVMAX 6 5800-6/3800-6 TROUBLESHOOTING “XY” ISSUES

1. Selection will not vend.
  - a. Does a different selection vend?
    - i. Perform Test Vend in TEST Menu ensure proper selection vends.
    - ii. Check Custom Space to Sales has been enabled.
      1. Check FIFO Mappings in Product Configuration Menu.
  - b. Did the gate actuate at all?
    - i. Plunger cycled but gate but did not fully actuate.
      1. Gate Sticking.
        - a. Check plunger to target alignment in Test Menu, Platform Movement.
        - b. Shuttle bad.
        - c. Bent pins.
        - d. Check gear box & follower.
      2. Possible delivery cup assembly position alignment problem
        - a. Plunger should hit approximately ¼” from top edge of target.
          - i. Adjust shelf offset see programming “Security Code Menu, enter the Manufacturing Security Code 5555, go to Factory Set-up, Shelf Offset and adjust as needed”.
        - b. Perform vend test on selections, Test Menu, Test Vend.
          - i. Only occurs on one column.
            1. Defective target.
            2. Defective gear box.
            3. Defective follower.
          - ii. Occurs on entire shelf.
            1. Shelf not secured on supports.
            2. Position alignment.
          - iii. Occurs on same column, multiple shelves (A2, B2, C2, D2, E2).
            1. Shelf not secured on supports.
            2. Position alignment.
      3. Plunger did not cycle fully.
        - a. Replace plunger return spring.
        - b. Replace delivery cup assembly.
        - c. Replace I/O Control board.
    - ii. Gate did actuate
      1. Product and gate mismatch.
      2. Possible delivery cup assembly position alignment problem
        - a. Plunger should hit approximately ¼” from top edge of target.
        - b. Adjust shelf offset see programming “Security Code Menu, enter the Manufacturing Security Code 5555, go to Factory Set-up, Shelf Offset and adjust as needed”.
        - c. Perform vend test on selections.
          - i. Only occurs on one column.
            1. Defective target.
            2. Defective gear box.
            3. Defective follower.
        3. Dirty / worn tray slide with pusher.
          - a. Check slide with pusher, clean or replace as needed.

2. Delivery Cup Assembly Plunger Issues.
  - a. Plunger jam/dry vend.
    - i. Plunger return spring bad.
      1. Replace plunger return spring.
    - ii. Syrup/dirt/broken part causing plunger to stick.
      1. Replace delivery cup assembly.
    - iii. Software did not attempt to vend
      1. Check error list in Diagnostics Menu for cause & solution.
  - b. Plunger Hits Chassis.
    - i. Check tray is level and secured to tray supports.
    - ii. Check harness connections.
    - iii. Check X motor (bottom right).
  - c. Plunger Stays Out.
    - i. Check for syrup or dirt build up.
    - ii. Check for broken parts.
    - iii. Replace return spring.
    - iv. Check Harness connections.
  
3. Delivery Cup Assembly Will Not Go Home.
  - a. Is there a "Vend Timeout Error" on the display?
    - i. If yes check lower (Y) and top far left (X) home switches.
      1. In Test Menu, Platform Movement test check switch functions:
        - a. At the home position the "Y" (lower) home switch will register as On if switch is pressed and good.
        - b. At the home position the "X" (top far left) home switch will register as On if switch is pressed and good.
          - i. Adjust the X drive belt.
  
4. Elevator will not move vertically.
  - a. Perform Test Vend in Test Menu to test movement.
  - b. Check top door switch.
    - i. Is it functioning?
    - ii. Is it being made when door is closed?
  - c. Check the Delivery Cup Plunger & Plunger Home Switch.
    - i. If plunger arm is stuck out it will shut down XY delivery system.
    - ii. If plunger arm home switch fails it will shut down XY delivery system.
  - d. Check the harness connector to the "Y" motor.
  - e. Check rollers.
  - f. Check harness and motor.
  - g. Replace I/O Control board.
  
5. Elevator will not move horizontally.
  - a. Perform Test in Test Menu to test movement.
  - b. Check top door switch
    - i. Is it functioning?
    - ii. Is it being made when door is shut?
  - c. Check the lower (Y) and top far left (X) home switches.
    - i. In Test Menu, Platform Movement test check switch functions:
      1. At the home position the "Y" (lower) home switch will register as On if switch is pressed and good.
      2. At the home position the "X" (top far left) home switch will register as On if switch is pressed and good.
        - a. Adjust the X drive belt.
  - d. Check the Delivery Cup Plunger & Plunger Home Switch
    - i. If plunger arm is stuck out it will shut down XY delivery system.
    - ii. If plunger arm home switch fails it will shut down XY delivery system.



- iii. Check rollers.
  - iv. Check harness and motor.
  - v. Replace control board.
6. Product Will Not Load From Delivery Cup Assembly To Port Assembly.
- a. Perform Test Vend in Test Menu to test movement.
  - b. Check Model # is set to correct cabinet.
  - c. Check belt tension.
  - d. Check Service Wall Port Door Assembly is securely installed.
7. Port Assembly On Service Door Will Not Open.
- a. Perform Test in Test Menu Port and Cup Sensors to test switch.
    - i. Port Open Switch is Off when Port Door is closed and switch is in open position and good.
    - ii. Port Closed Switch is On when Port Door is closed and switch is pressed and good.
  - b. Check for syrup or dirt build up, or debris.
  - c. Check for broken parts.
  - d. Replace port assembly.
  - e. Check harness and motor.
  - f. Replace I/O Control board.
8. Double Vend From Gate
- a. Is correct gate assembly used for product being vended?
  - b. Too many packages loaded in column.
  - c. Check Plunger Return Spring.
  - d. Check Cup Motor Cam.
  - e. Check the trigger on the Plunger Assembly.
  - f. Check the Picker Cup Ribbon Cable for bad connection or damage.
  - g. Check the Y E Chain Harness for bad connection or damage.
  - h. Check the X/Y E Chain Harness for bad connection damage.
  - i. Change Y Motor Board.
  - j. Change Delivery (Picker) Cup Base Board.
9. Package Not Sliding On Slide Assembly.
- a. Vender not level.
  - b. Trays not secured to Tray Supports.
  - c. Slide not installed correctly.
  - d. Slide dirty. Clean and apply Armoral or Food Grade Silicone.
10. Delivery Cup Assembly Caught On Tray
- a. Check vender is level.
  - b. Check Shelf setting.
  - c. Check spring on Y belt is installed correctly.
  - d. Check rollers.

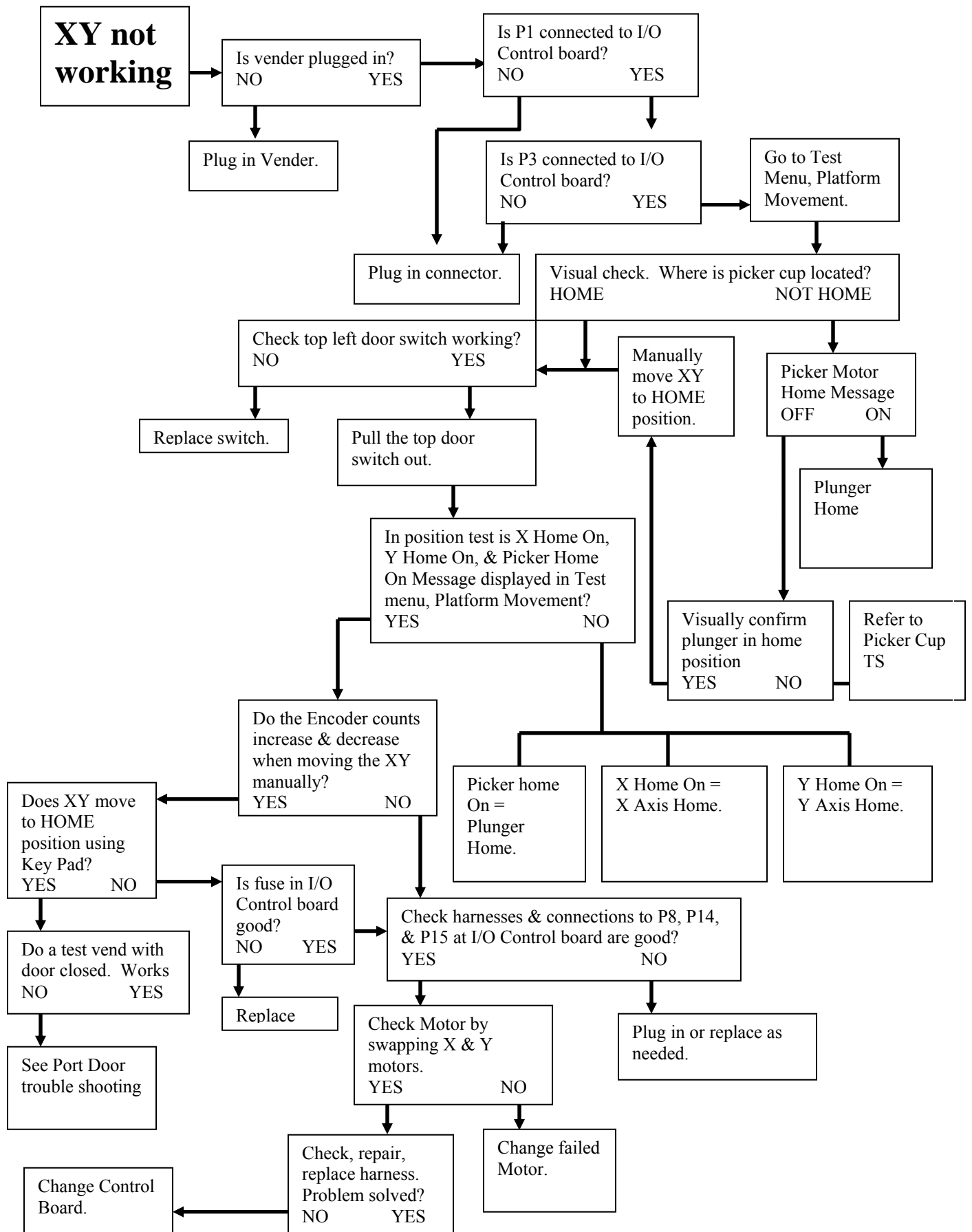

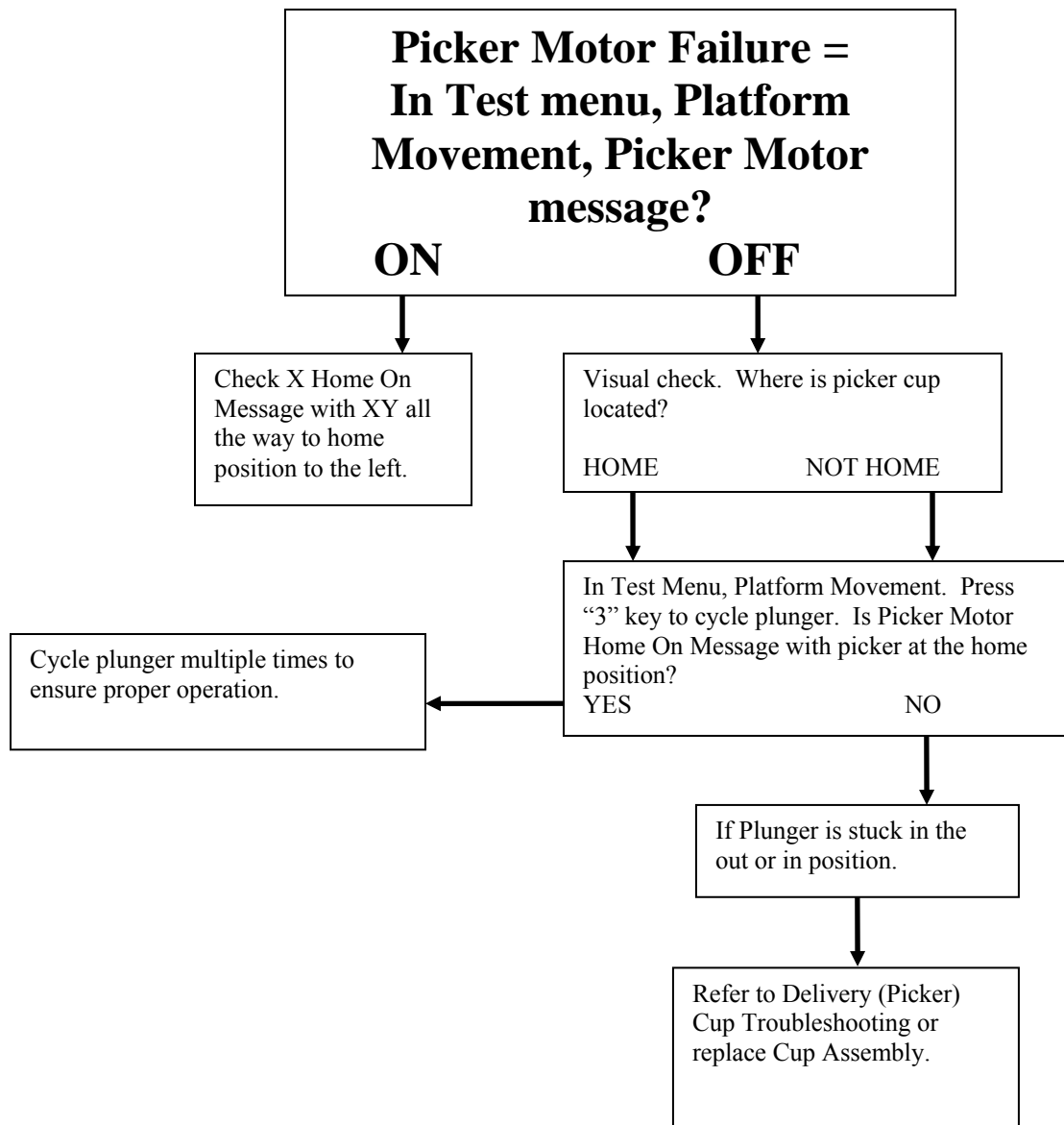

# X Motor Failure = In Test Menu, Platform Movement, is X Home message?

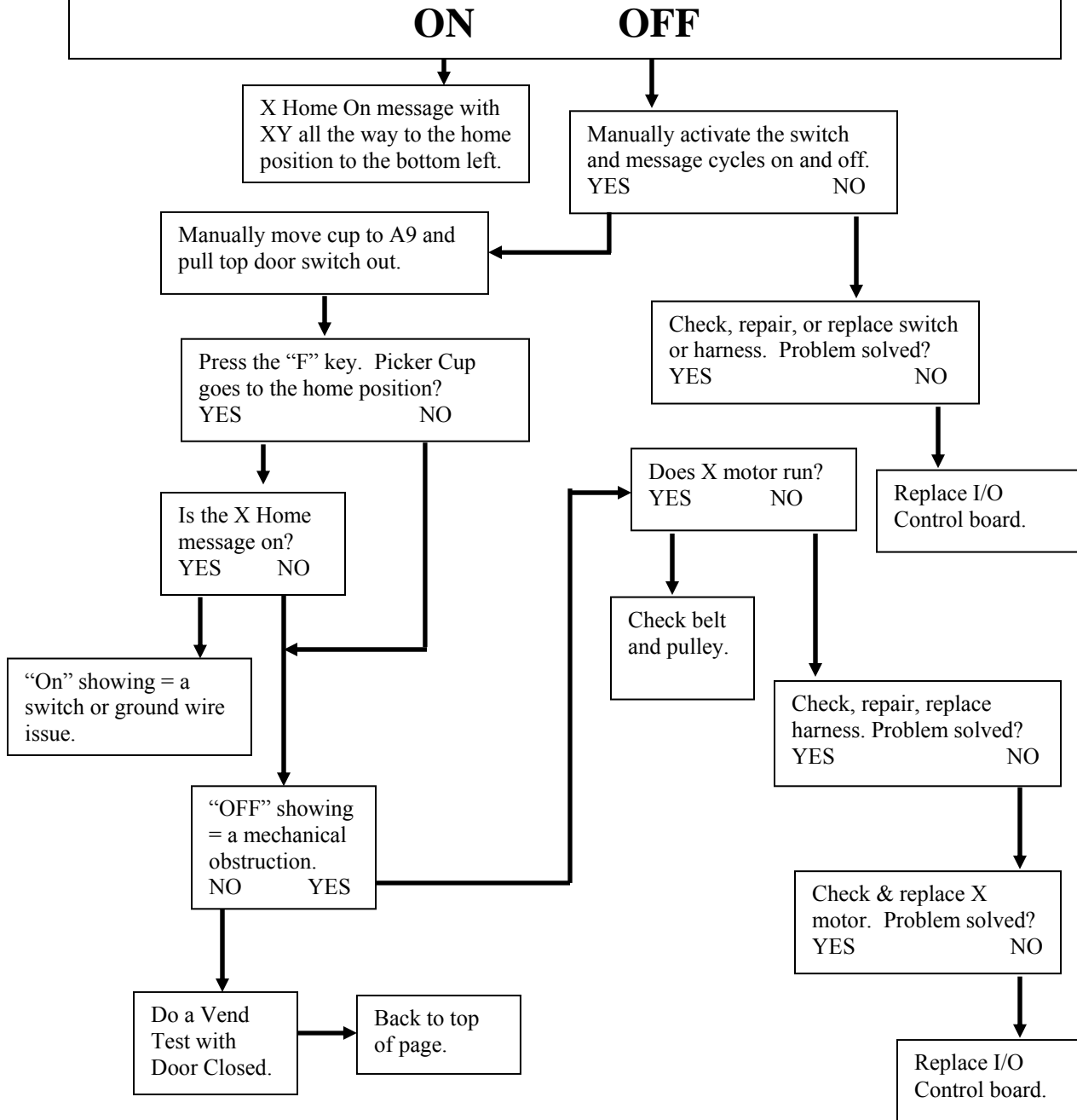

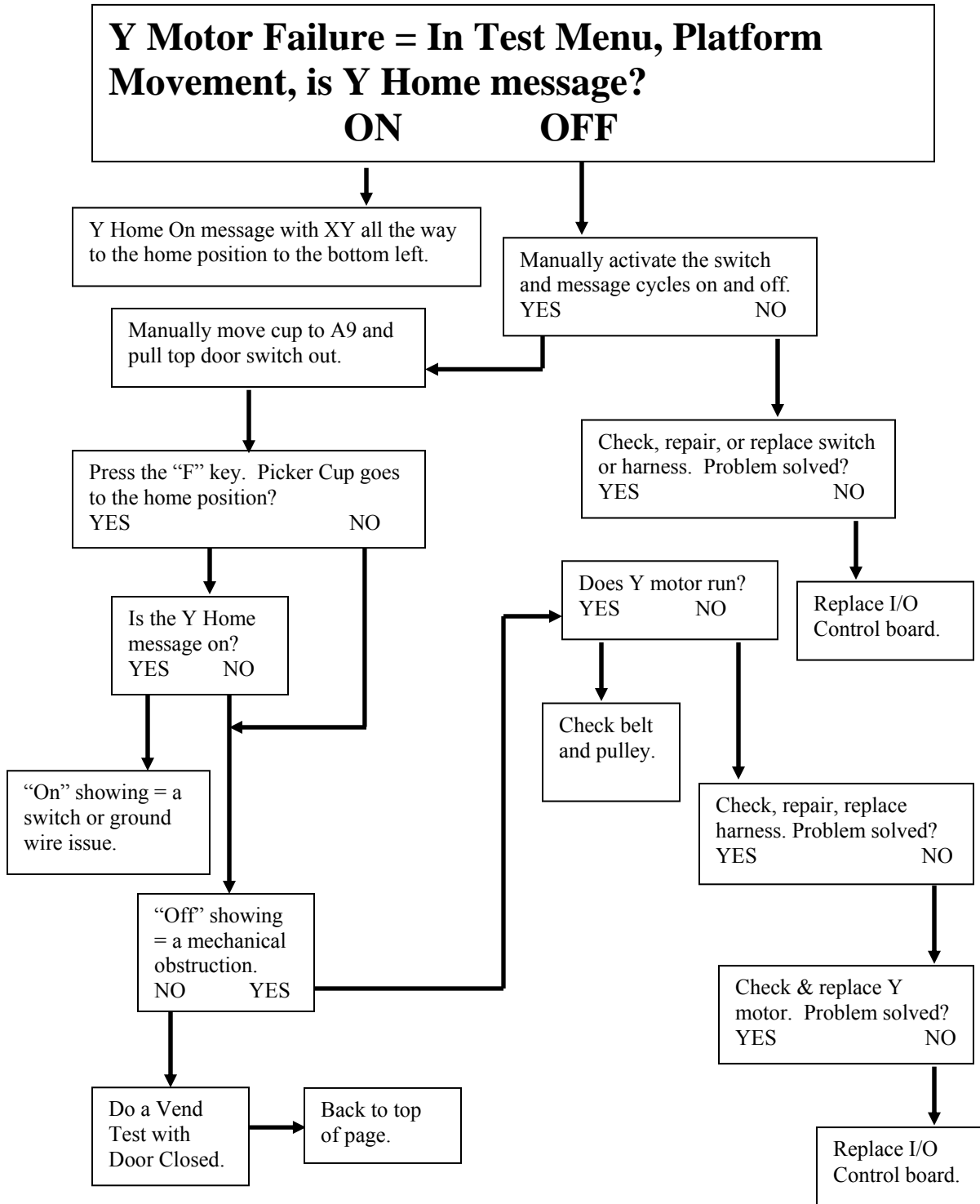

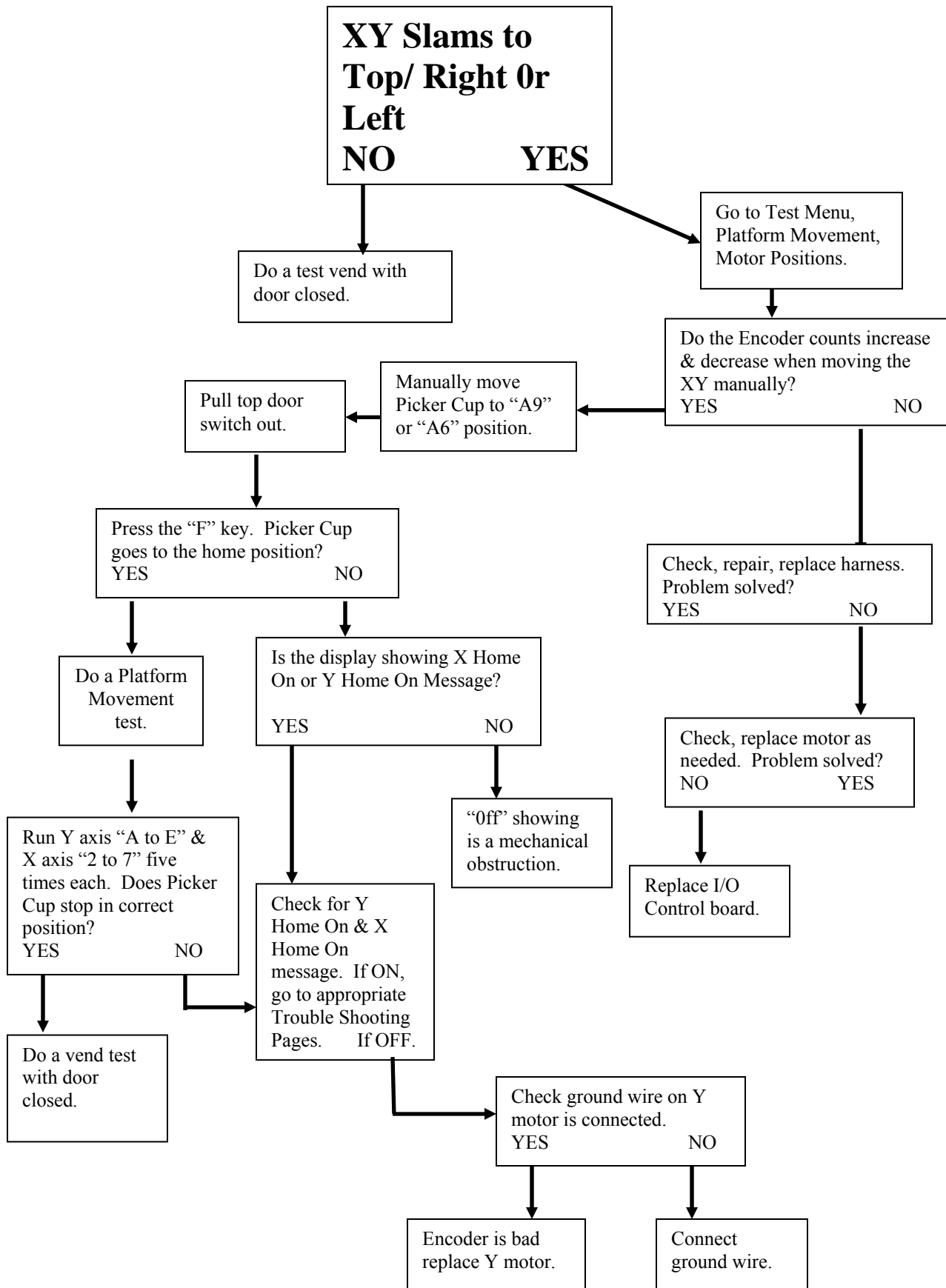

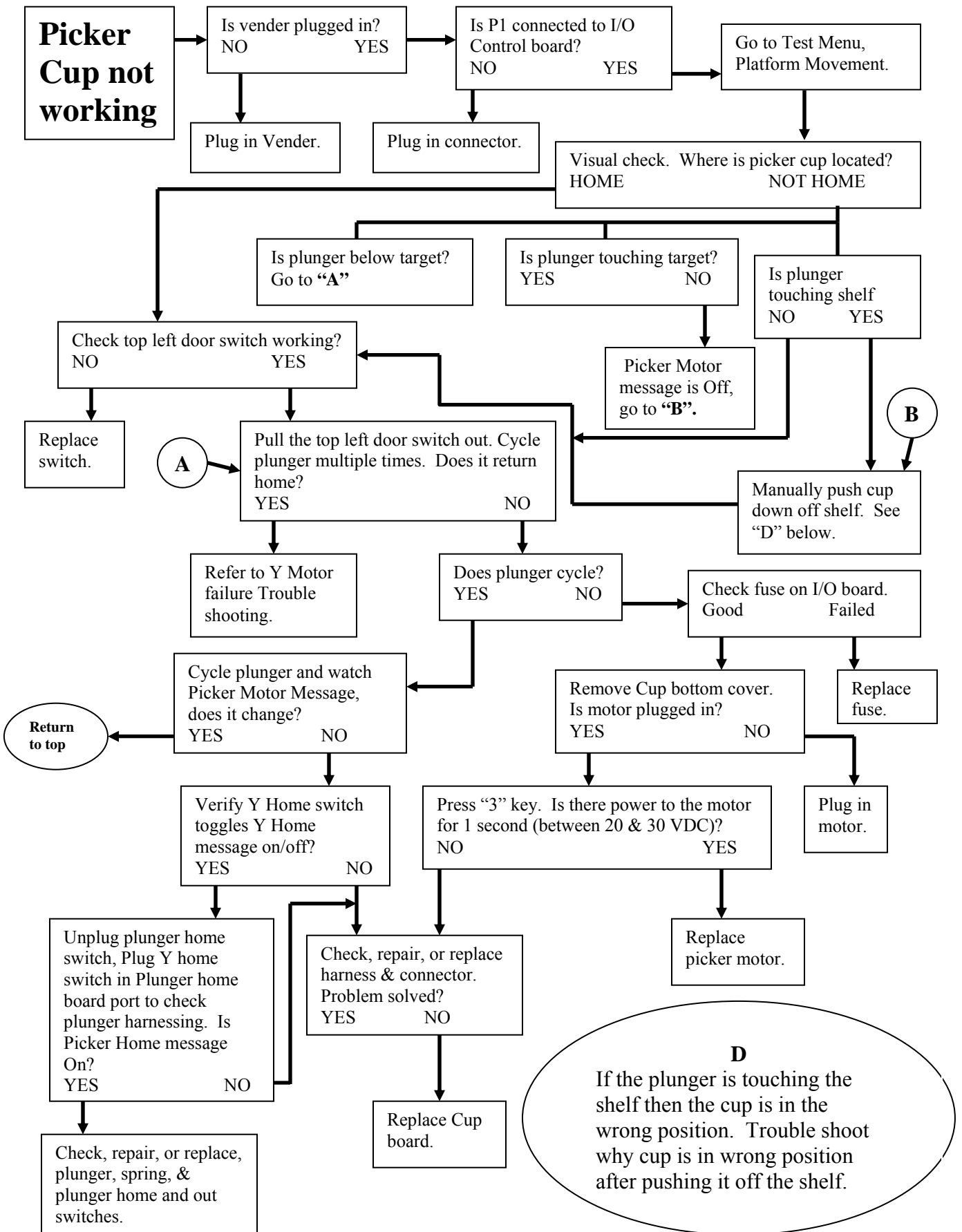

# CUP AT WRONG LOCATION HIGH/LOW or Y AXIS

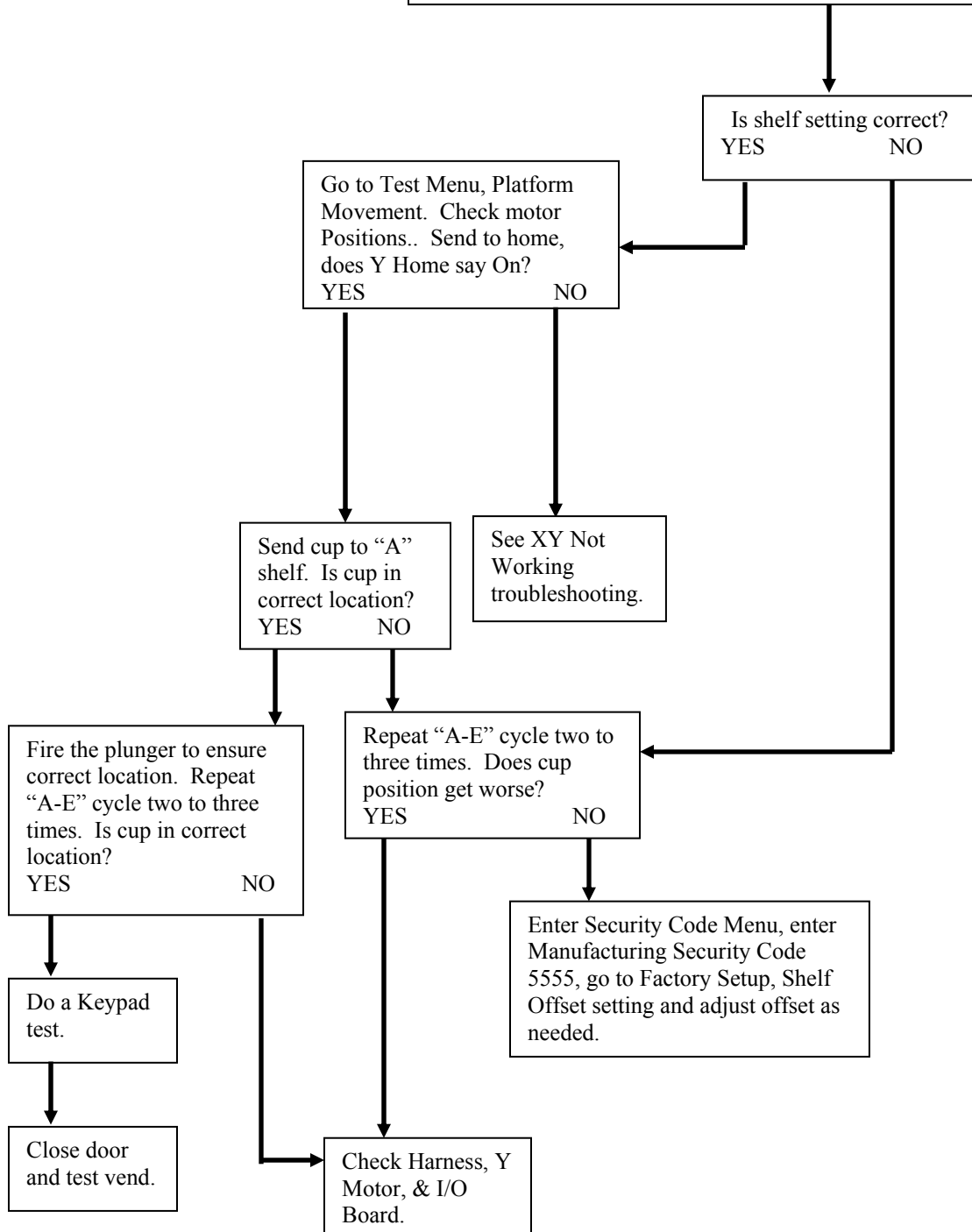



# CUP AT WRONG LOCATION LEFT /RIGHT or X AXIS

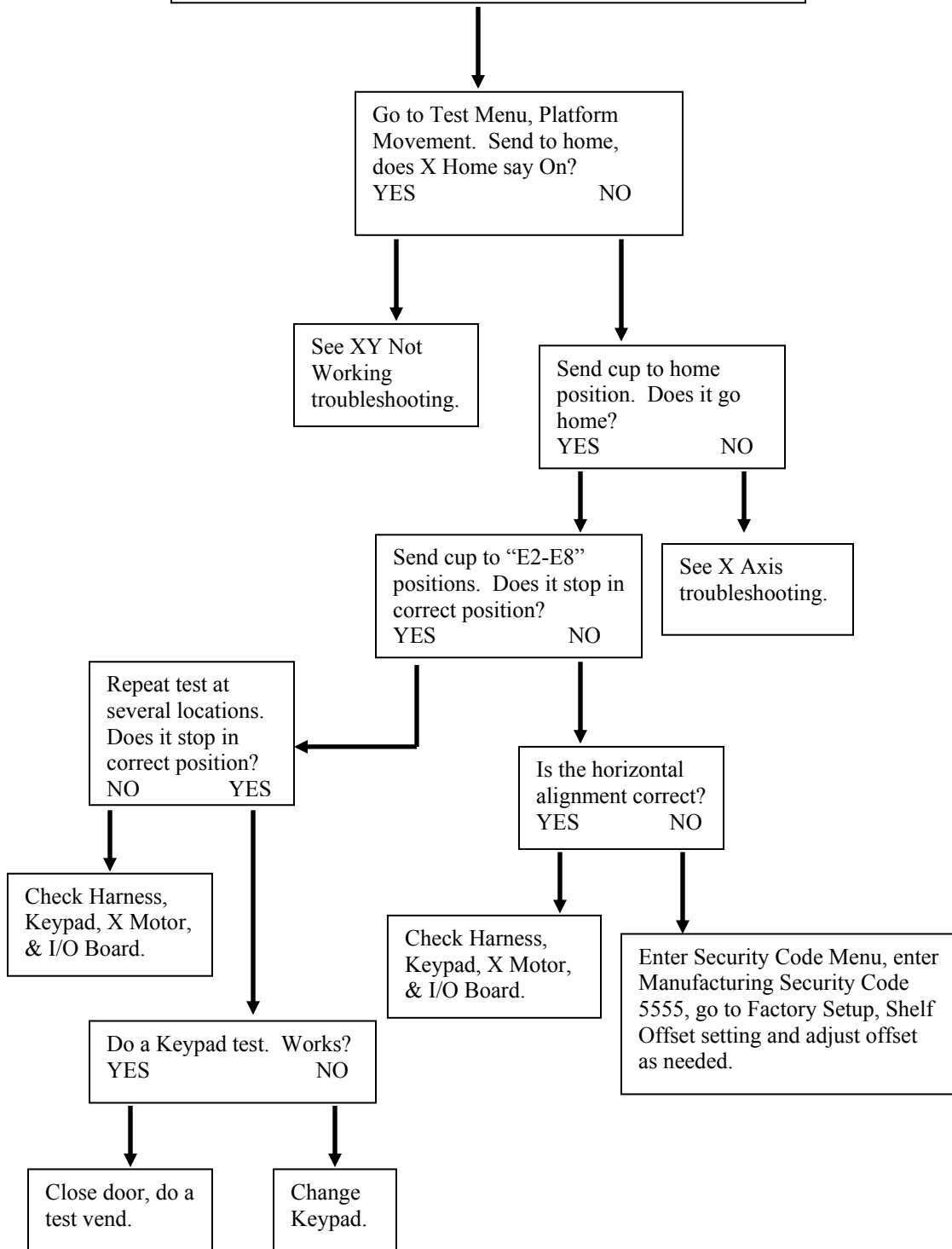

**DELIVERY PORT DOOR  
WORKS IN FACTORY  
DIAGNOSTICS BUT  
NOT IN SALES MODE**

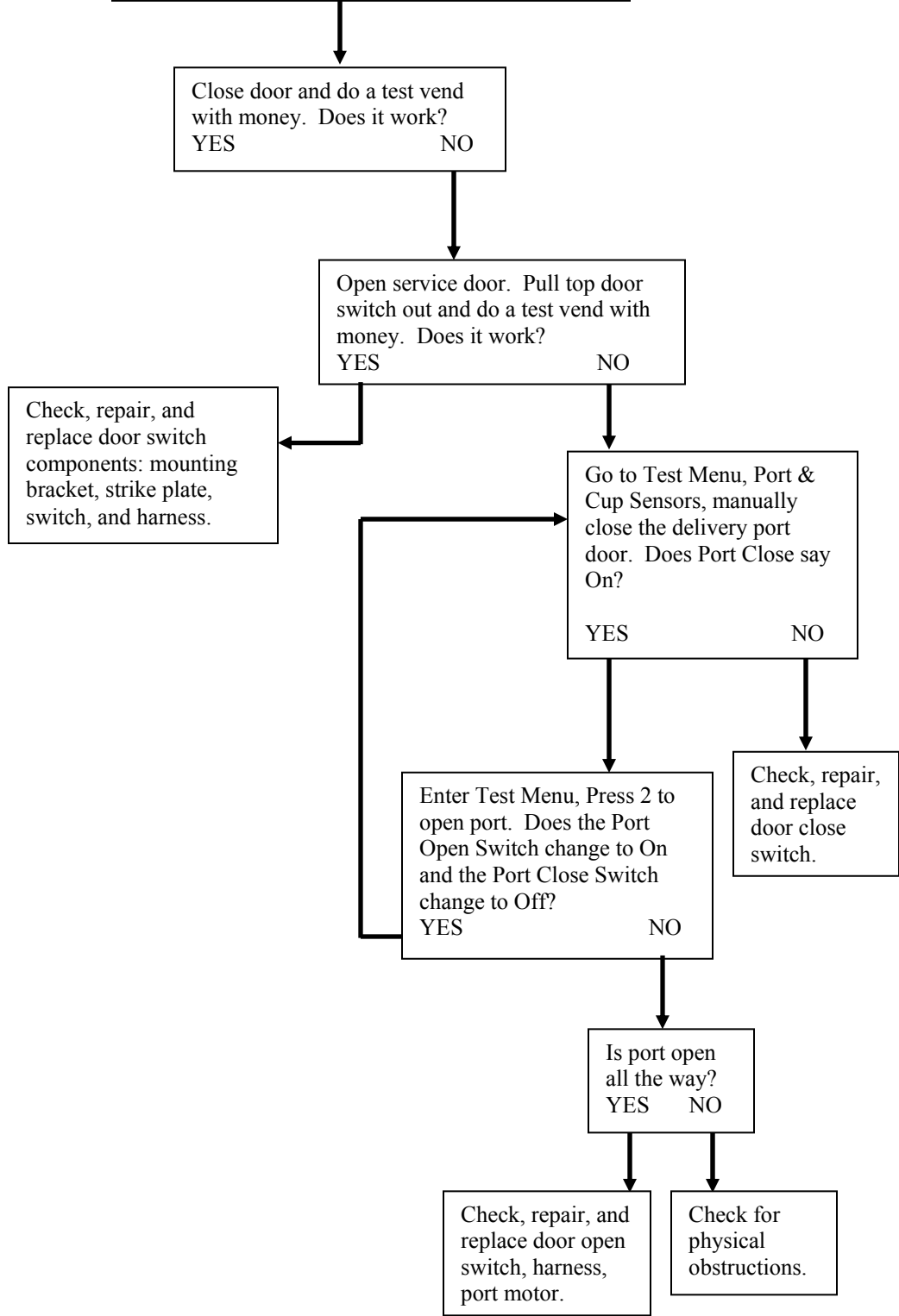

### COIN ACCEPTANCE ISSUES

PROBLEM	CAUSE	FIX
Coins Returned to Customer With No Credit Issued	<ol style="list-style-type: none"> <li>1. Coin Jam in Mech</li> <li>2. Flight Deck Dirty</li> <li>3. No Power to Mech</li> <li>4. Coin Return Lever Activated</li> <li>5. Vender in Programming Mode</li> <li>6. Timed Event, Inhibit Set</li> <li>7. Defective Coin Mech</li> </ol>	<ol style="list-style-type: none"> <li>1. Clear Jam and Test</li> <li>2. Clean Flight Deck</li> <li>3. Check Harness, Changer to Atlas Board.</li> <li>4. Adjust Coin Return Lever</li> <li>5. Close Service Door</li> <li>6. Disable Timed Event Inhibit</li> <li>7. Replace Mech</li> </ol>
Will Not Payback Coins	<ol style="list-style-type: none"> <li>1. No Power to Mech</li> <li>2. No Coins in Tubes</li> <li>3. Tubes Programmed Incorrectly</li> <li>4. Defective Coin Mech</li> </ol>	<ol style="list-style-type: none"> <li>1. Check / Replace MDB Harness</li> <li>2. Fill Coin Tubes with Coins</li> <li>3. Reprogram per Manufacturer Recommendation</li> <li>4. Replace Coin Mech</li> </ol>

### DOLLAR BILL ACCEPTANCE ISSUES

PROBLEM	CAUSE	FIX
Bill Validator will not run.	Prices / tube cash conditions.	Check Mech Tubes.
Takes Bill in Then Rejects it		Check Validator or Replace
Stacks Bill while in Escrow Mode	Max Price Not Yet Reached	
Bill Validator No Comms error listed in Diagnostics Menu, Diagnostics Errors.	Communication Error with Bill Validator. Bill Validator Reported Error.	
Takes Bill, Gives No Credit	Harness, Validator, Atlas Board	Check or Replace Validator, Harness, Atlas Board

### I/O CONTROL BOARD

PROBLEM	CAUSE	FIX
No Power to I/O Controller.	1. AC Box	1. Replace AC box.
Display blank or locked up.	<ol style="list-style-type: none"> <li>1. Incorrect Input to Atlas Controller</li> <li>2. Low or Missing 24 Volts</li> </ol>	<ol style="list-style-type: none"> <li>1. Check voltage to Atlas Controller.</li> <li>2. Make corrections to supply correct voltage.</li> </ol>
Out of Order or other error codes showing on display	RAM Error	Refer to Programming Section, Diagnostics, Diagnostics Errors for specific error codes and cures.
Temp out of Service	No Vendable Selections	

These charts are intended as a guide to isolate and correct most problems you might encounter. Should your machine show 'OUT OF SERVICE', go in the TEST MODE and press "B" to list errors.

### ALL COINS ARE REJECTED

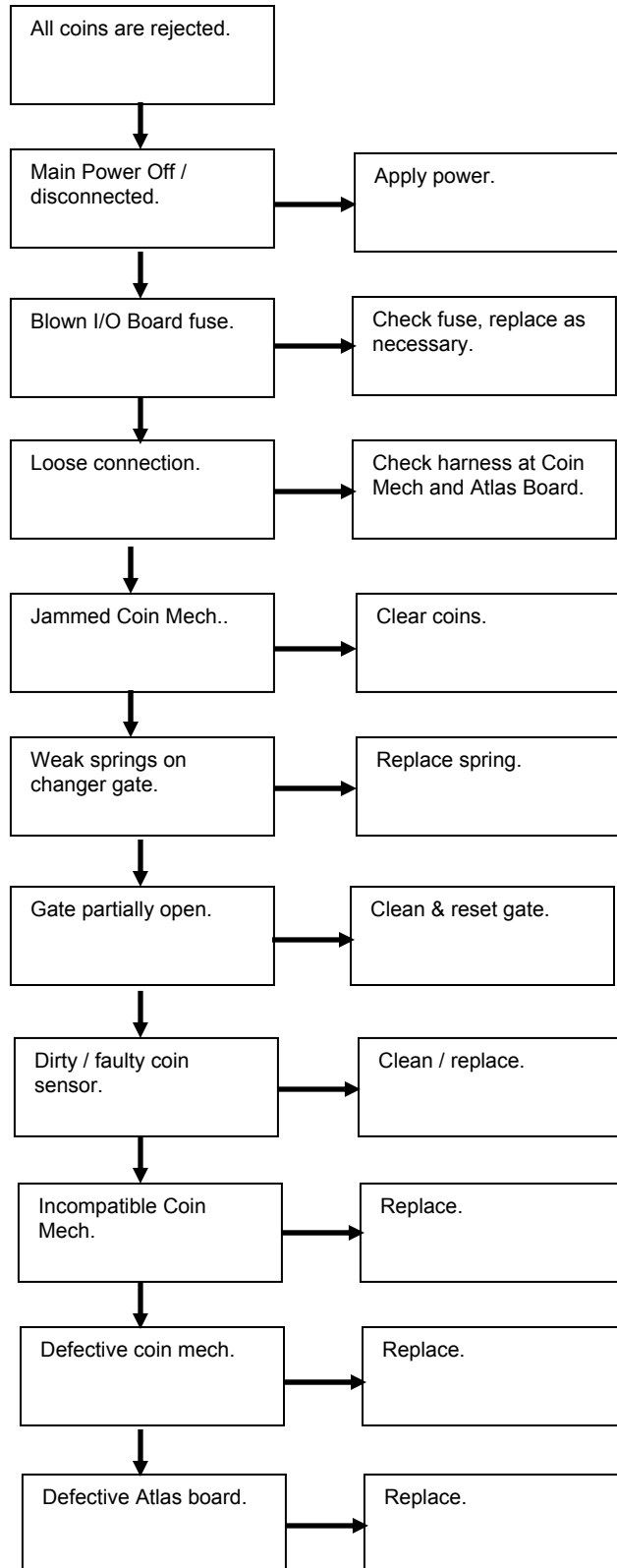

# ALL BILLS ARE REJECTED

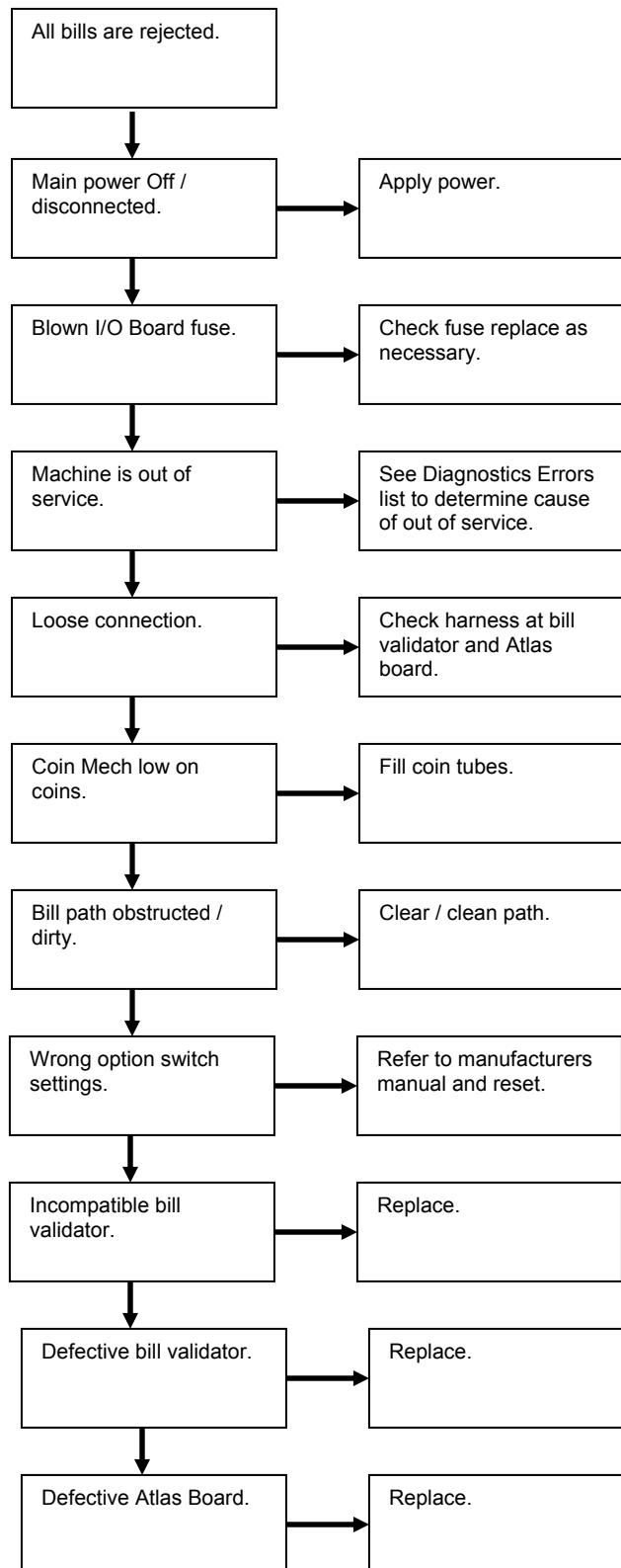

## INCORRECT CHANGE DISPENSED

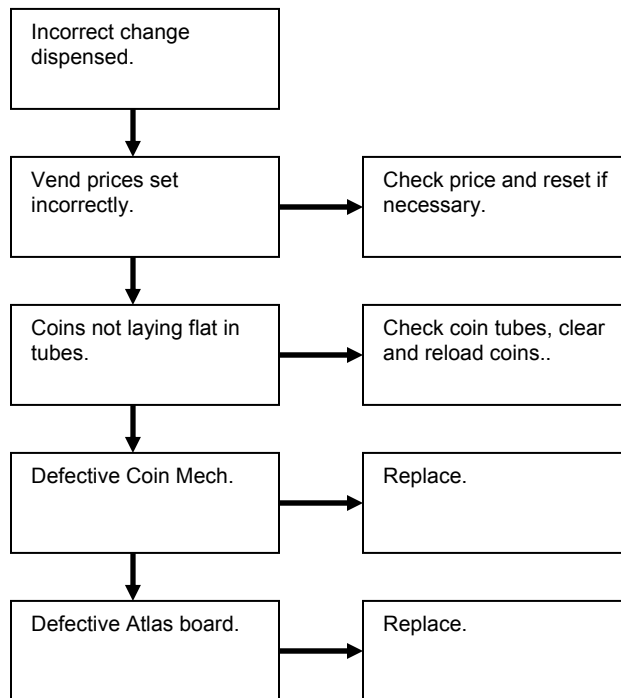

## SELECTION WILL NOT VEND

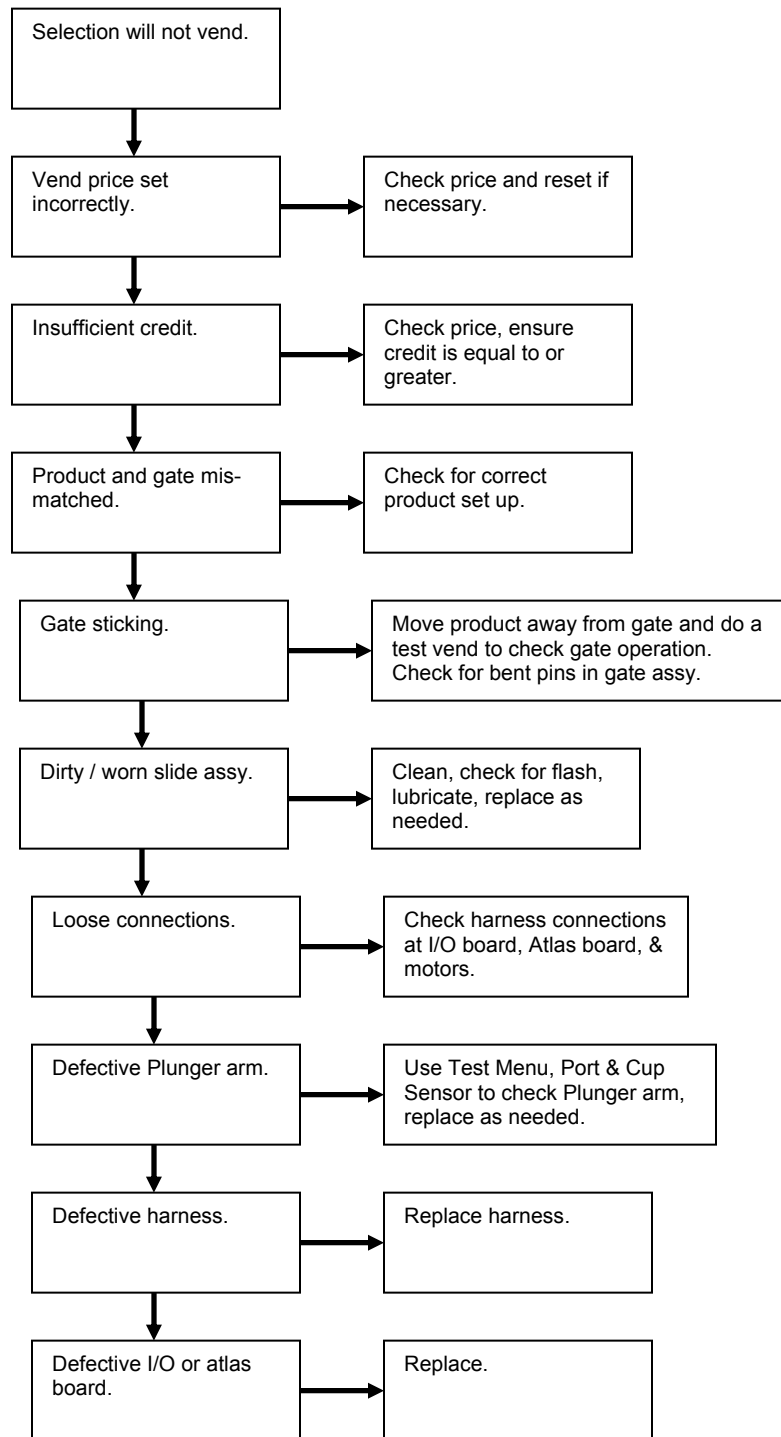

### ICE / FROST ON EVAPORATOR

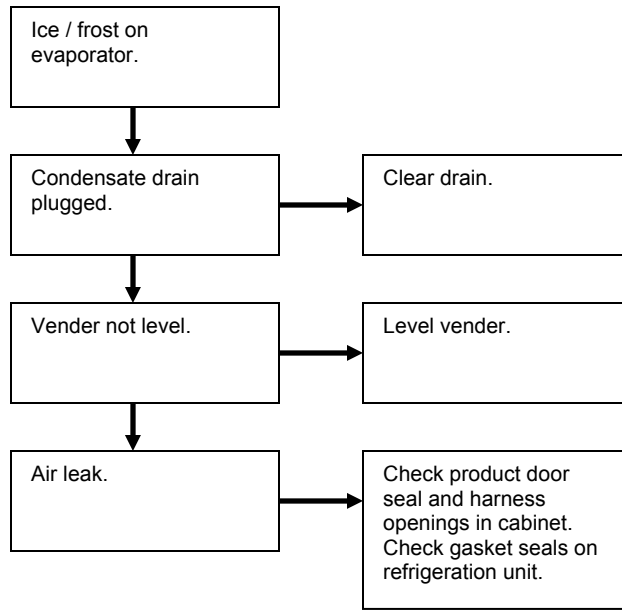

### CONDENSATE ON OUTSIDE OF PRODUCT DOOR

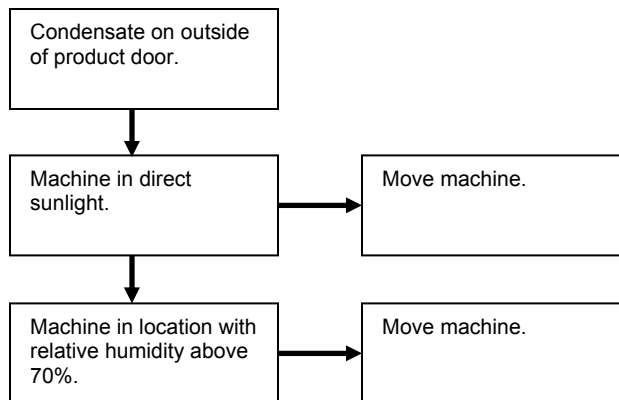

### COMPRESSOR WILL NOT STOP

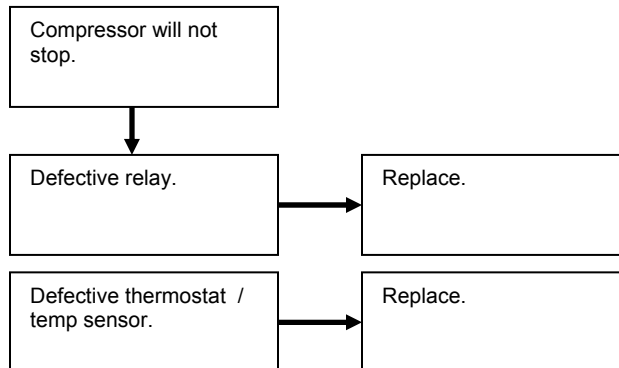



## COMPRESSOR WILL NOT START

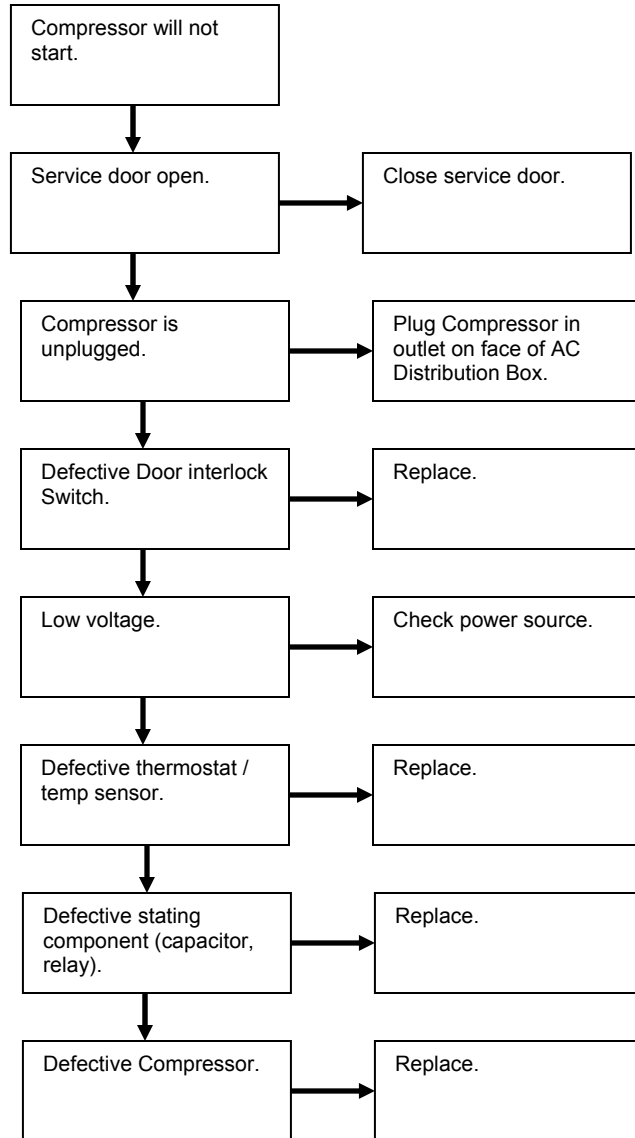

**Troubleshooting Tip:** For domestic venders use a short 15 AMP extension cord & plug the compressor directly to the wall outlet. This will bypass the AC Distribution Box.  
**IMPORTANT: FOR TESTING PURPOSES ONLY.**

### MACHINE NOT COOLING

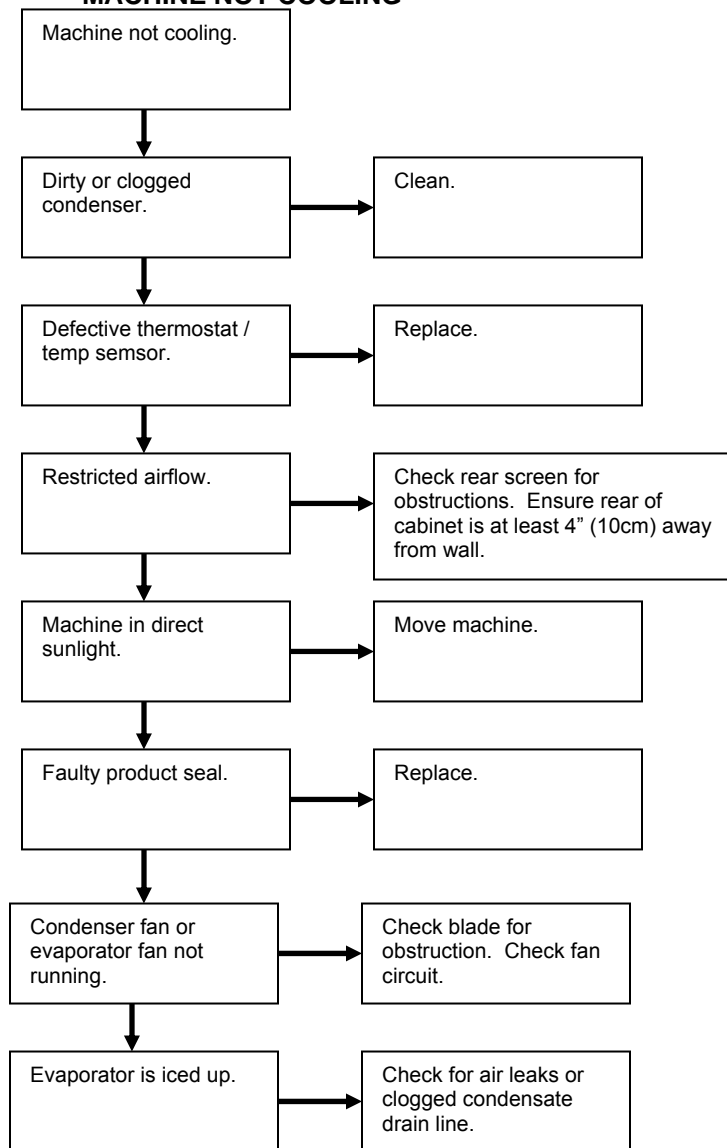

# Major Component Description

## AC DISTRIBUTION BOX

### BevMax 6 5800-6/3800-6

110 VAC units

Main Power Switch / Plug 15 Amp Outlet (110 VAC)	Interrupts hot side of incoming power to all components in machine. Provides power to Refrigeration unit.
---	--

Transformer (T1)	Provides 24 Volt power to the Controller Board.
------------------	---

### BevMax 6 DN5800-E6/3800-E6

220 VAC units

Main Power Switch / Plug	Interrupts hot side of incoming power to all components in machine.
--------------------------	---

Receptacle, Panel Mount IEC 320 (220 VAC)	Provides power to Refrigeration unit.
--	---------------------------------------

Transformer (T1)	Provides 24 Volt power to the Controller Board.
------------------	---

## Service Door Switches

**2 Switches - Left Switch** (10 Amp) – in XY Motor Circuits, Port Door Motor Circuit, and Picker Motor Circuit (Power Interrupt Switch).

**2 Switches - Right Switch** (10 Amp) – in Controller and Electronic Lock Circuit (Electronics Switch).

## General Maintenance

The most important facets of proper care and maintenance of your machine are the electrical power supplied to it, leveling, and cleanliness of the machine.

## POWER

Refer to the cabinet serial number plate to determine the correct voltage and frequency for the machine. In the US and Canada this is 120Vac, 60Hz, 1P. In Europe, Australia, and other export countries, this is 220/230/240Vac, 50Hz, 1P depending upon your country voltage. The serial plate also specifies the ampere rating of the machine. This machine must be plugged into a properly rated receptacle with its own circuit protection (fuse or circuit breaker).

---

### **CAUTION:**

**REMOVE POWER TO THE AC DISTRIBUTION BOX BEFORE CLEANING OR WHEN ANY ELECTRICAL COMPONENTS ARE CONNECTED / DISCONNECTED FOR TESTING OR REPLACEMENT.**

---

**Periodically inspect the power supply cord for damage. If the cord or plug is worn or damaged, it must be replaced with a power supply cord of the same type, size and specification as originally provided with the machine. DO NOT USE THE VENDING MACHINE UNTIL THE WORN OR DAMAGED CORD IS REPLACED.**

In Domestic Vending Machines the Ground Fault Circuit Interrupter (GFCI) must be tested frequently and before each use in accordance with the instructions provided on the GFCI device. **IF THE GFCI DOES NOT PASS THE TEST, DO NOT USE THE MACHINE.** Unplug the supply cord from the receptacle and call the Crane Merchandising Systems Technical Support Group for assistance at 1-803-266-5001.

---

### **CAUTION:**

**REMOVE POWER TO THE AC DISTRIBUTION BOX BEFORE CLEANING OR WHEN ANY ELECTRICAL COMPONENTS ARE CONNECTED / DISCONNECTED FOR TESTING OR REPLACEMENT.**

---

## CLEANING

---

*DO NOT USE A WATER JET OR NOZZLE TO CLEAN THE VENDER*

---

### GLASS DOOR

The display glass should be cleaned inside and out with paper towels and glass or non-abrasive all-purpose cleaner. The gasket around the product door should be wiped down using warm water, any mild general purpose, non-abrasive cleaner and a soft towel. Never lubricate the gasket and always check for cracking or deformities which may cause leaks. Replace if necessary.

### TRAYS / TRAY INSERTS

The trays and tray inserts should be cleaned periodically using warm water and a mild general purpose, non-abrasive cleaner. Care should be taken to ensure debris does not enter the gear box assemblies. **DO NOT USE SOLVENTS OR ABRASIVE MATERIALS TO CLEAN ANY PORTION OF THE TRAY.**

### SLIDE/PUSHER ASSEMBLY

The slide/pusher assembly should be cleaned periodically using warm water and any mild general-purpose non-abrasive cleaner. After drying, the slide assembly needs to have a coat of Armoral applied. Care should be taken to ensure debris does not enter the gear box assemblies. **DO NOT USE SOLVENTS OR ABRASIVE MATERIALS TO CLEAN ANY PORTION OF THE TRAY.**

### DOOR LIGHTING

The machine is designed with an energy efficient LED Lighting System. To ensure continued reliable operation, replace only with the same type and size lamps. Lamps must be properly installed and connected.

### CABINET

Wash the cabinet with a good detergent or soap mixed in warm water. Wax the vender often with a good grade of automobile wax. Any corrosion inside the vender should be removed with fine steel wool and the area should be painted with white paint.

Repair any scratches on painted surfaces to prevent corrosion.

### DRAIN PAN, DRAIN TUBE, AND DRAIN HOSE

To prevent mold and mildew growth, and to avoid personal injury or property damage, the drain pan, drain tube, and drain hose must be properly aligned and routed. Ensure nothing obstructs the drain tube or drain hose and that the hose is not bent, pinched, or twisted in such a way as to prevent the flow of condensate. Periodically inspect the drain pan, drain tube, and drain hose for alignment and the presence of dirt, debris, mold, and mildew. Clean as needed.



---

### WARNING

**THE COMPRESSOR ELECTRICAL CIRCUIT IS ALWAYS LIVE WHEN THE PLUG IS CONNECTED TO AN ELECTRICAL OUTLET.**

---

### REFRIGERATION CONDENSER

Clean the condenser periodically of dirt or lint build-up. Remove the build up with a brush or vacuum, or blow the dirt out of the condenser with compressed air and approved safety nozzle. Ensure nothing obstructs air intake at the bottom of the main door. Ensure nothing obstructs air exhaust at the rear of the cabinet.

## **COIN ACCEPTOR**

Follow the Coin Acceptor Manufacturer's instructions.

## **LUBRICATING THE VENDER**

The vender refrigeration system does not require any field lubrication. The hermetic refrigeration system and fan motors are manufactured with lifetime lubrication.

## **NEW ATLAS CONTROL BOARD INSTALLATION**

Setting Model Number - On power up the display will show "Reset Model? Continue? Yes / No". Press the icon and display will show "No Model Set Save? ^ (scroll up) Yes / No". Press up or down arrow icon to scroll through available model numbers DN5800-6, DN3800-6, DN5800-E6 (export), DN3800-E6 (export). With vender model displayed that you are installing board press the Done icon to save.

**BevMax 6 5800-6/3800-6 Domestic Block Diagram**

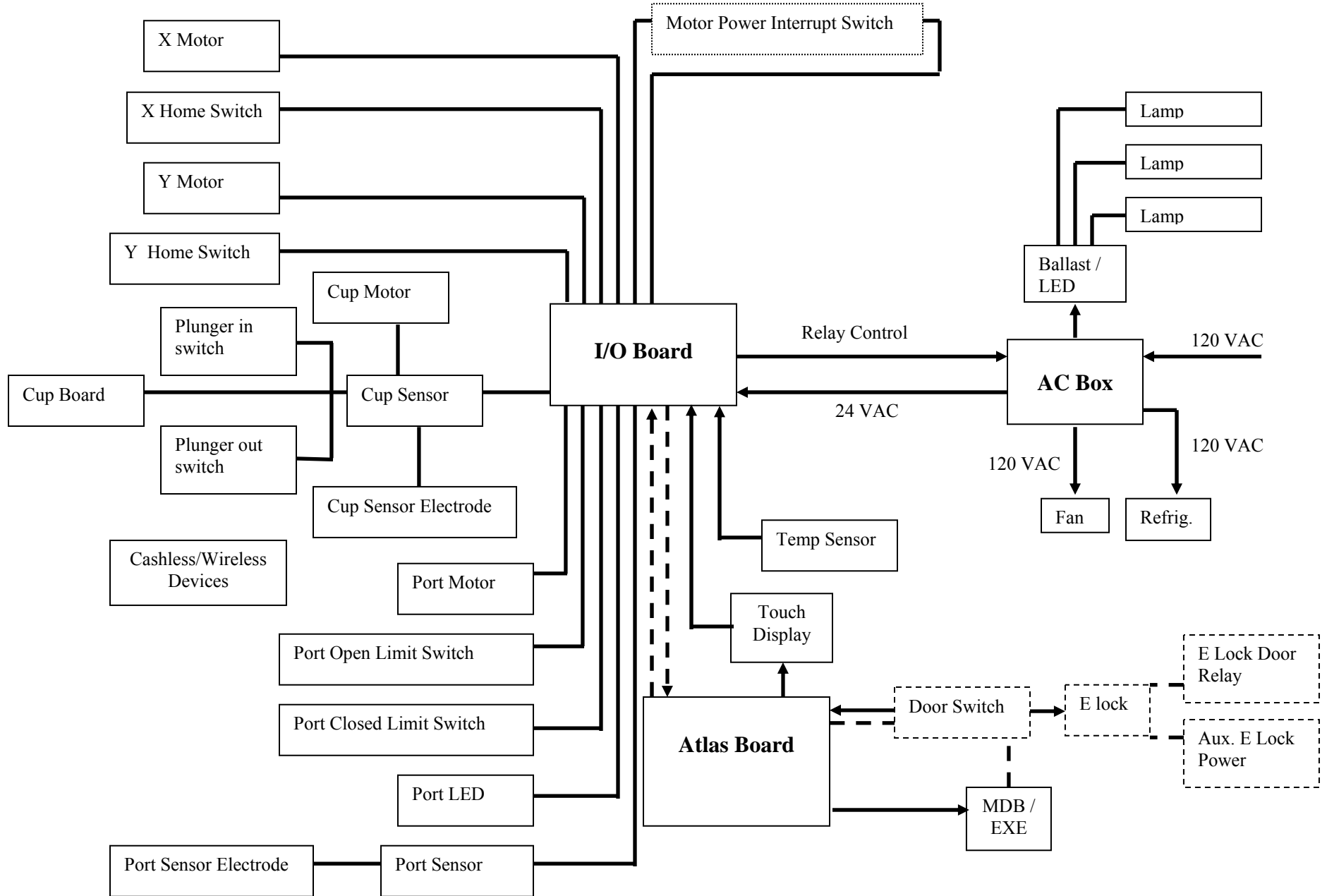

BevMax 6 5800-E6/3800-E6 Export Block Diagram

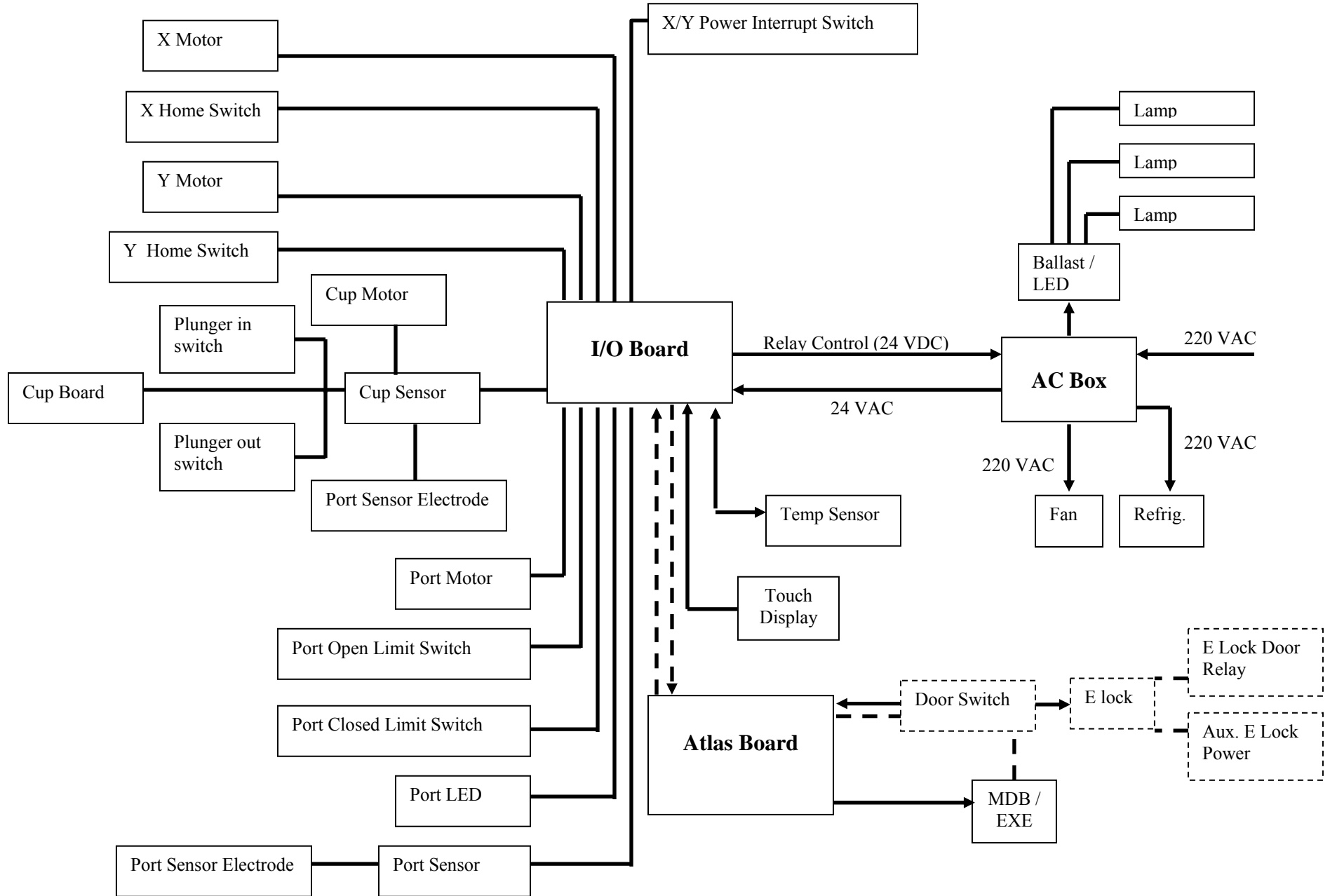

## BevMax 6 5800-6/3800-6 Compressor Parts Diagram

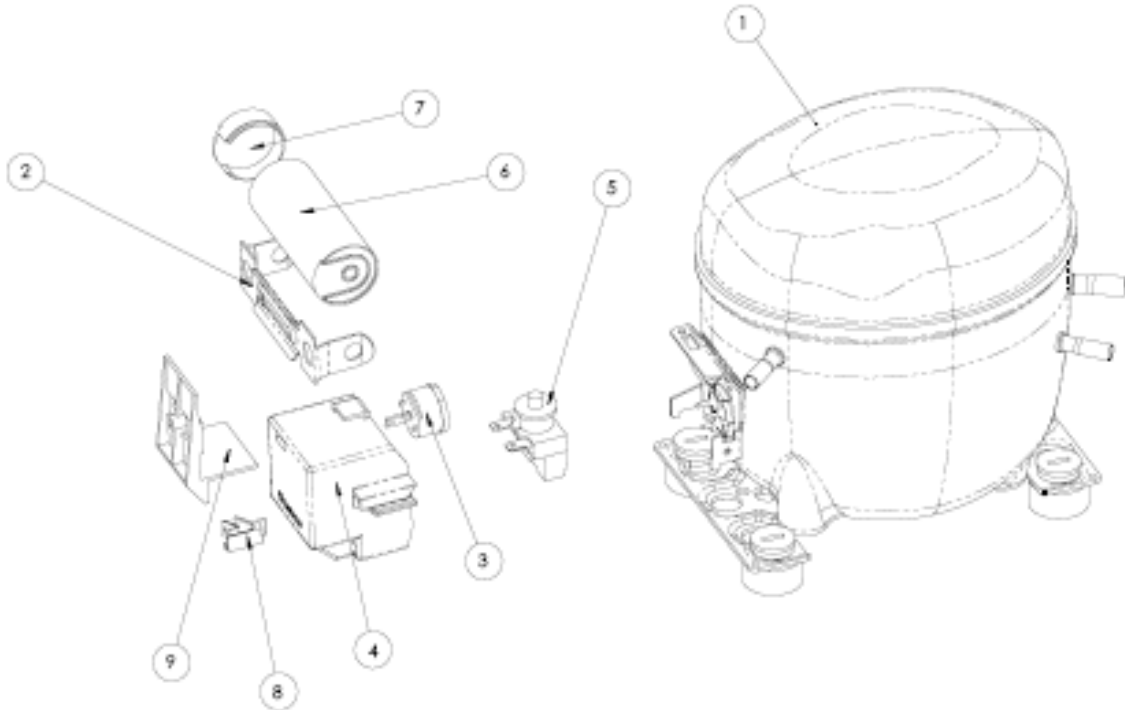

### Domestic Compressor Parts BevMax 6 5800-6/3800-6 65701270 Domestic Refrigeration Kit

Item #	Part #	Description
1	80250289	Compressor, Embraco FFU130HAX 115/60 (EM# 513200620)
2	80240217	Bracket, Capacitor FFU130HAX (EM#US-2255008)
3	80240213	Overload, Compressor FFU130HAX (EM#513554617)
4	80240214	Cover, Electrical Component FFU130HAX (EM#13555028)
5	80240216	Relay, Compressor Start FFU130HAX (EM#213516051)
6	80240218	Capacitor, Compressor Start FFU130HAX (EM#US-3252378)
7	80240220	Cap, Capacitor FFU130HAX (EM#2254002)
8	80240215	Cord, Relief FFU130HAX (EM#513545045)
9	802,402,21x.x1	Holder Capacitor FFH130HAX (EM#513555135)
10	R134A	Freon (9.5oz or .269kg)



## BevMax 6 5800-E6/3800-E6 Compressor Parts Diagram

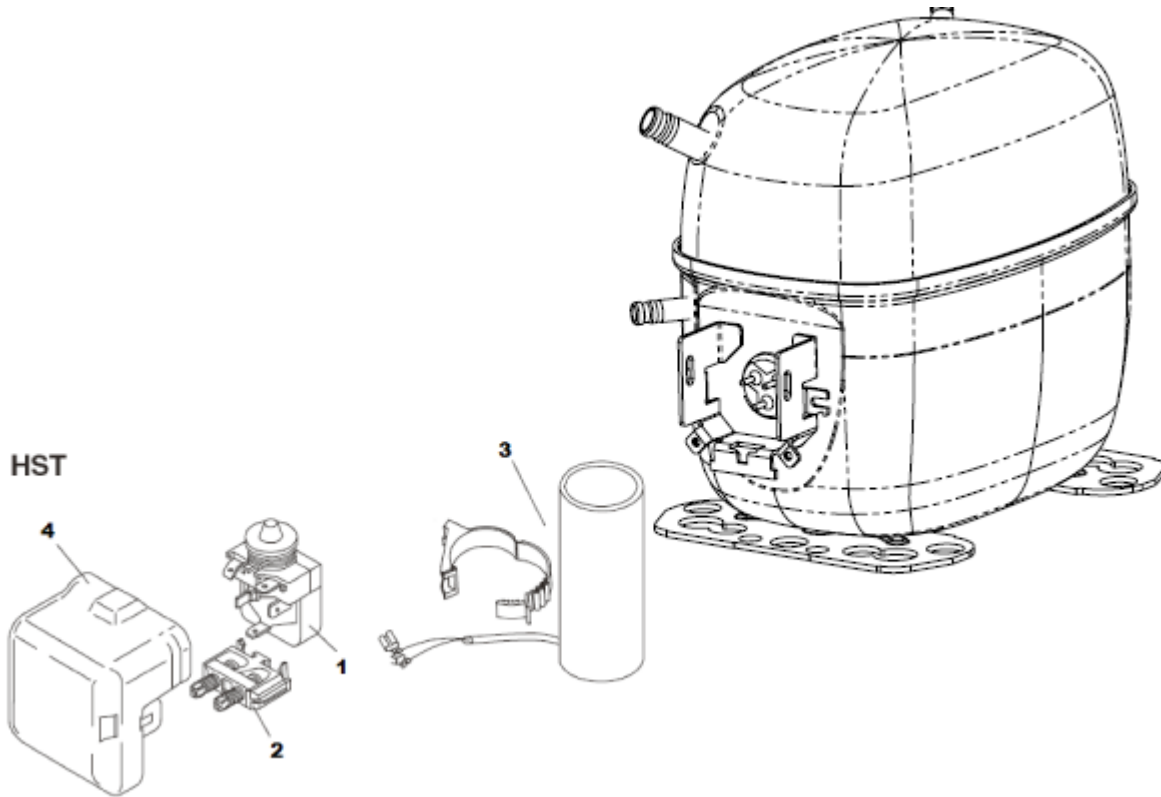

### Export Compressor Parts BevMax 6 5800-E6/3800-E6 65701290 Export Refrigeration Kit

Item #	Part #	Description
	CR0004162	Compressor, Export
1	CR0004863	Starting Relay, Danfoss
2	CR0004865	Cord, Relief Compressor Danfoss
3	CR0004174	Capacitor, Compressor Start 80 $\mu$ F, Danfoss
4	CR0004172	Cover, Electrical Component FFU130HAX (EM#13555028)
5	R134A	Freon (9.5oz or .269kg)